

OLYMPUS

Your Vision, Our Future

Life Science Microscopes

BX53, BX63

BX3 Research Microscope Systems

ryf ag



Ryf AG
Bettlachstrasse 2
2540 Grenchen
tel 032 654 21 00
fax 032 654 21 09

www.ryfag.ch

Research Microscopy – Built by Your Needs





VERSATILE SYSTEMS FOR INDIVIDUAL SUCCESS

Our technology: Your advantage

As microscopy becomes increasingly popular, a greater range of people require the perfect tool for their particular research areas. These tools must not only provide the optical capabilities to enable the breathtaking insights and robust data required, but also the flexibility to suit their particular working style. Both these cornerstones are embraced by the Olympus BX3 microscope systems.





REMAINING IN CONTROL

Maximising research output

Research microscopy is about more than just the microscope or the imaging capability, as each investigation requires a unique set-up. As a result, each system must not only be highly flexible, but also able to excel at a great multitude of protocols and processes. The Olympus BX3 microscopes are just such instruments, offering excellent hardware and software modularity embedded in a flexible imaging system environment and ensuring that, whatever the task, the researcher will always remain in control.



Built by your needs

6–19

Investigative tools always provide the best results if they are able to fit closely with the needs of the experiment. Imagine how much more can be achieved if such tools fit closely with the researcher as well; workflow efficiency, long-term comfort, improved results ...

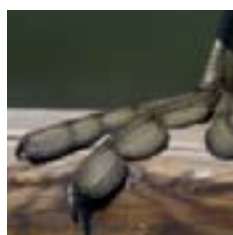

The system is you

20–31

Whether you are looking for an entry-level manual microscope, a partially motorised research microscope, or a fully automated imaging system, the Olympus BX3 microscope range and its extensive accessories will match to you exactly. As a result you can have your system your way.

Your vision: Our future

Olympus is dedicated to making state-of-the-art microscopes, accessories and imaging system solutions to support your work on all levels. We have therefore worked closely with customers to produce the ultimate in flexible microscopy – the BX3 range. As a result, our goal is your success, both now and in the future.



BUILT BY YOUR NEEDS

Your microscope, powered by Olympus

At Olympus we know how to get the most out of an optical system, how to motorise and automate, and how to tie everything together for seamless operation; but it is only you who knows exactly what you want to achieve and how you want to do it. Together therefore, we can create the perfect imaging system for your research, whatever that may be.

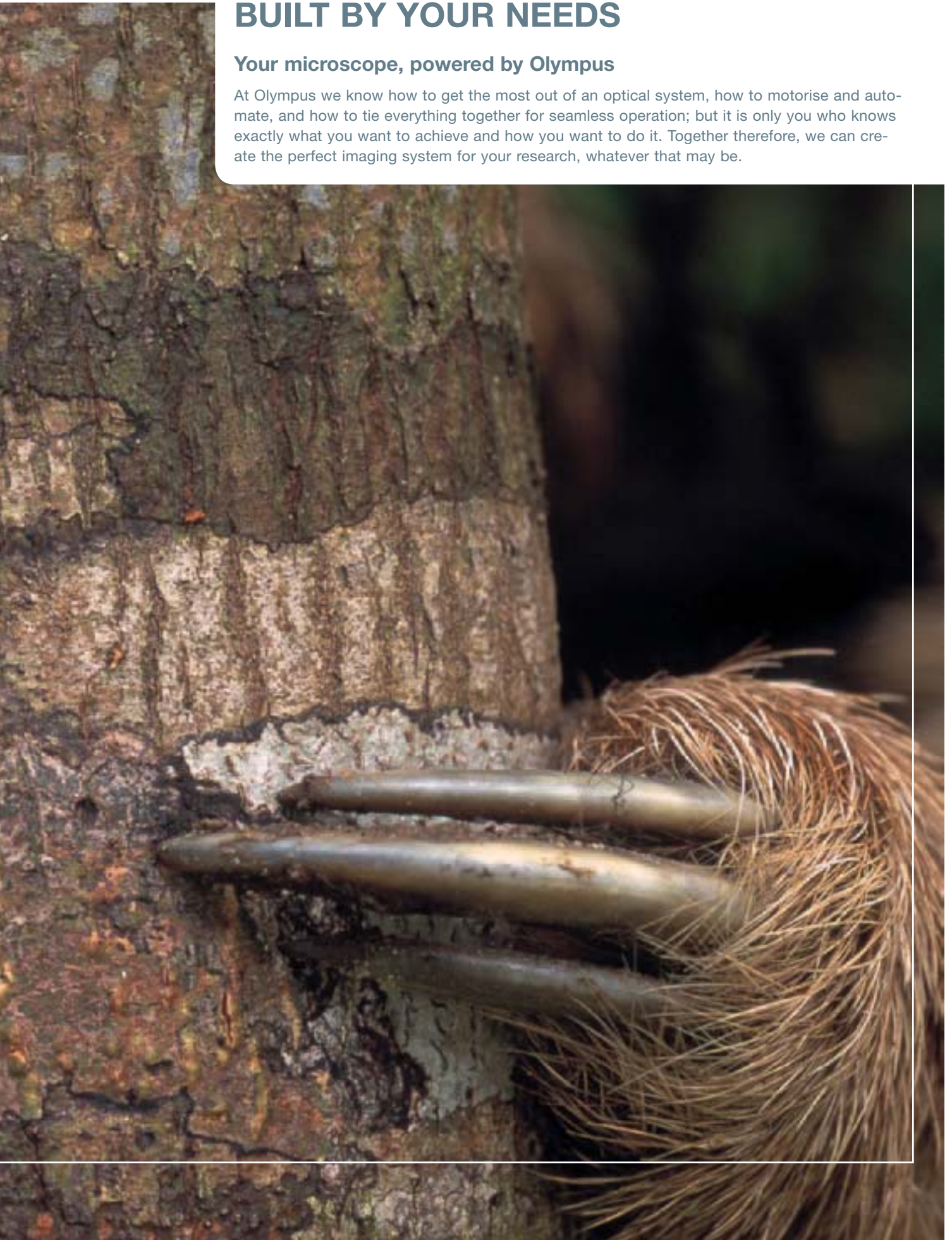

A Ambidextrous frame design

All important microscope controls are accessible from either side or can be adapted for left and right-handed users.

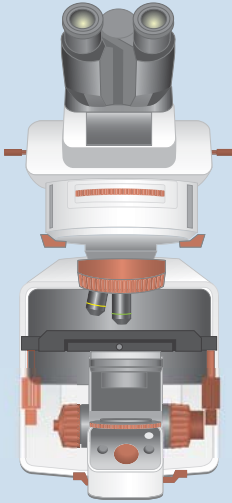

FLEXIBILITY THROUGH DESIGN

As with quality, true flexibility is a trait that must be designed into an instrument at every stage. With this very aim, Olympus applied all of its know-how and developed the BX3 range of upright research microscopes. These microscopes – the BX53 and BX63 – are the ultimate expressions of imaging system versatility; offering extensive choice with numerous optical, motorisation and software options, along with ongoing adaptability during use.

Ambidextrous

A F You install your new microscope and it looks great except for one thing – it is designed for right-handed users and you are left-handed. But what can you do about it? Well, the Olympus BX3 microscopes are designed to be ambidextrous so you don't have to be! For example, the light control dial is placed in the centre of the frame, and the transmitted attenuation filters and fluorescence shutters can be operated from either side, as can the focus knobs. If the microscope is fitted with an Olympus digital camera, a remote exposure button is available, which can also be placed on either side of the frame, enabling uninterrupted image framing and capture. As a result you maintain full control over your workspace, consequently improving workflow efficiency as everything is exactly where you want it.



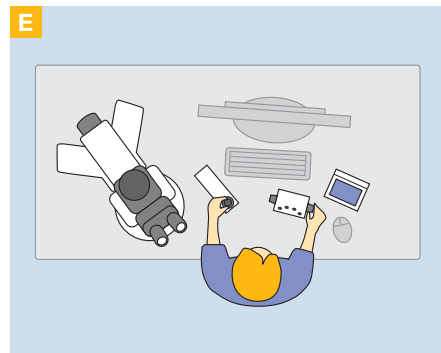
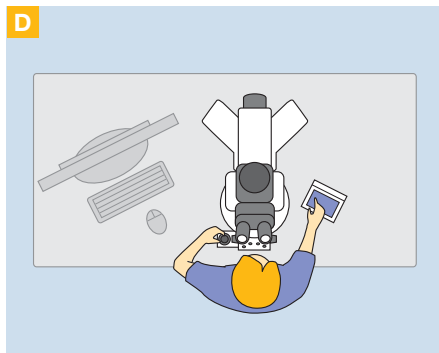
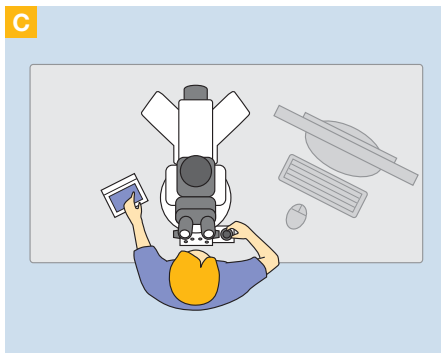

Ultimate adaptability

C–E Every person has a different way of organising their things – be it their work desk or their wardrobe – and their way will not necessarily suit anyone else. Olympus has enabled this complete user-defined control concept with its BX63 microscope.

Intuitive control solutions

B The BX63 is supplied with a unique, programmable touch screen control that greatly simplifies repetitive observation and imaging tasks. The interface can be set to a “guidance mode” that is context-sensitive, displaying only the functions that are relevant to the observation method in use. The alternative “full operation” mode allows researchers access to the full range of functions and customisation options available.

In addition to the touch screen control, the BX63 can also be fitted with a detachable remote control, providing the effect of traditional mechanical knobs for focus and stage position. There are also buttons for efficiently changing between observation methods, objectives and mirror units, as well as for adjusting light intensity. The XY control of the motorised stage can be fixed on either side of, or even separated from, the main focus and button control unit, providing for absolute user customisation of control placement. There are also two programmable buttons on the main control unit providing an additional level of personalisation.

As a result, a user that prefers a classic microscope-centred work area can achieve their ideal set-up just as easily as a scientist who prefers to navigate their samples on screen with the control in front of them and the microscope to the side. The BX63 really does open up a world of possibilities for workspace management.

Ergonomically ideal

G Each user has very individual posture and positional requirements, and therefore as well as enabling personalised work areas, the ability to adjust microscope controls aids in providing an ergonomic environment suitable for long-term microscope use without leading to positional or repetitive strain injuries. The other main point of contact for a user with the microscope is the observation tube and eyepiece lenses. A range of tubes are available for the BX3 range to suit every requirement. For the greatest system flexibility and user comfort, the tilting, ergonomic trinocular tube provides excellent eyepiece height adjustment as well as interpupillary distance control, and the optical path slider can be attached to either side of the tube, once again putting the user in full control of the microscope and ensuring that the microscope adjusts to their posture and not vice versa.

F Ambidextrous frame design

All controls are accessible from both sides



G Ergonomic trinocular tube

Tilttable from 5° to 35°



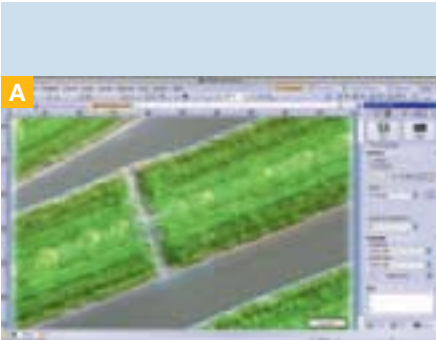

Free and flexible positioning of tool-windows ...

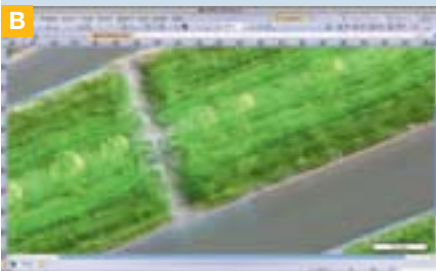

... according to personal preference ...



... and workflow

CONTROL AND COORDINATION

A – C The fully customisable control concept of the Olympus BX3 microscope systems continues seamlessly with the cellSens software, with personalisable tool placement and user-definable workflows. The Olympus cellSens software family is also perfectly placed to provide all of the tools required to power your ideal system, whatever that may be.

Dynamic interface

The adaptability of the BX3 microscopes enables personalised work areas, a concept that is also implemented in the cellSens software to provide dynamic, user-defined workflows. Olympus has developed a number of key process interface layouts, within which researchers can set their own workflows. As a result, each process layout is matched to the exact requirement of the user or the application. The number of available layouts increases with the complexity of the cellSens package in use as, for basic image capture for example, there is no requirement for object detection.

- **Acquisition layout** – for selecting between different acquisition processes and adjusting the camera settings
- **Processing layout** – this is where measurements are completed on the image and the measurement functions are therefore clearly displayed
- **Object detection** – determination of particle quantities based on threshold classification and multivariant object definition
- **Reporting layout** – the report generating functions bring together all of the tools required for documenting and passing on the results

A BLANK CANVAS

It is your workflow, so with cellSens you can have it your way: Within each of the predefined layouts users can specify how many tools and controls are shown on screen, eliminating unnecessary controls and placing the frequently used ones exactly where they are wanted.

Our expertise in your hands

Olympus has brought its imaging and analysis expertise directly to you via the unique workflow management concept. This novel idea guides users, step-by-step, through all tasks from basic image capture to multiple image alignment and on to advanced processes utilising microscope automation. In effect, the workflow management concept ensures there are no mistakes, just reproducible results.

Integration, not re-education

Olympus cellSens software programs have been developed to integrate seamlessly with Microsoft Windows and Microsoft Office software programs, rather than re-inventing key processes. As a result you will feel at home using them, even for complex processes like statistical analysis, which are completed directly in Excel, or for report template generation in Word.

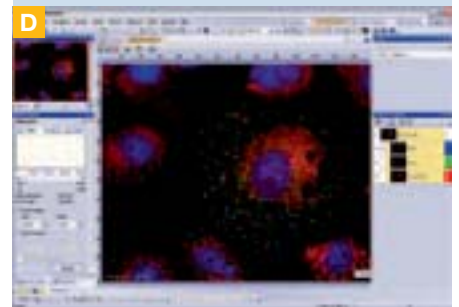

cellSens: application-oriented user interface

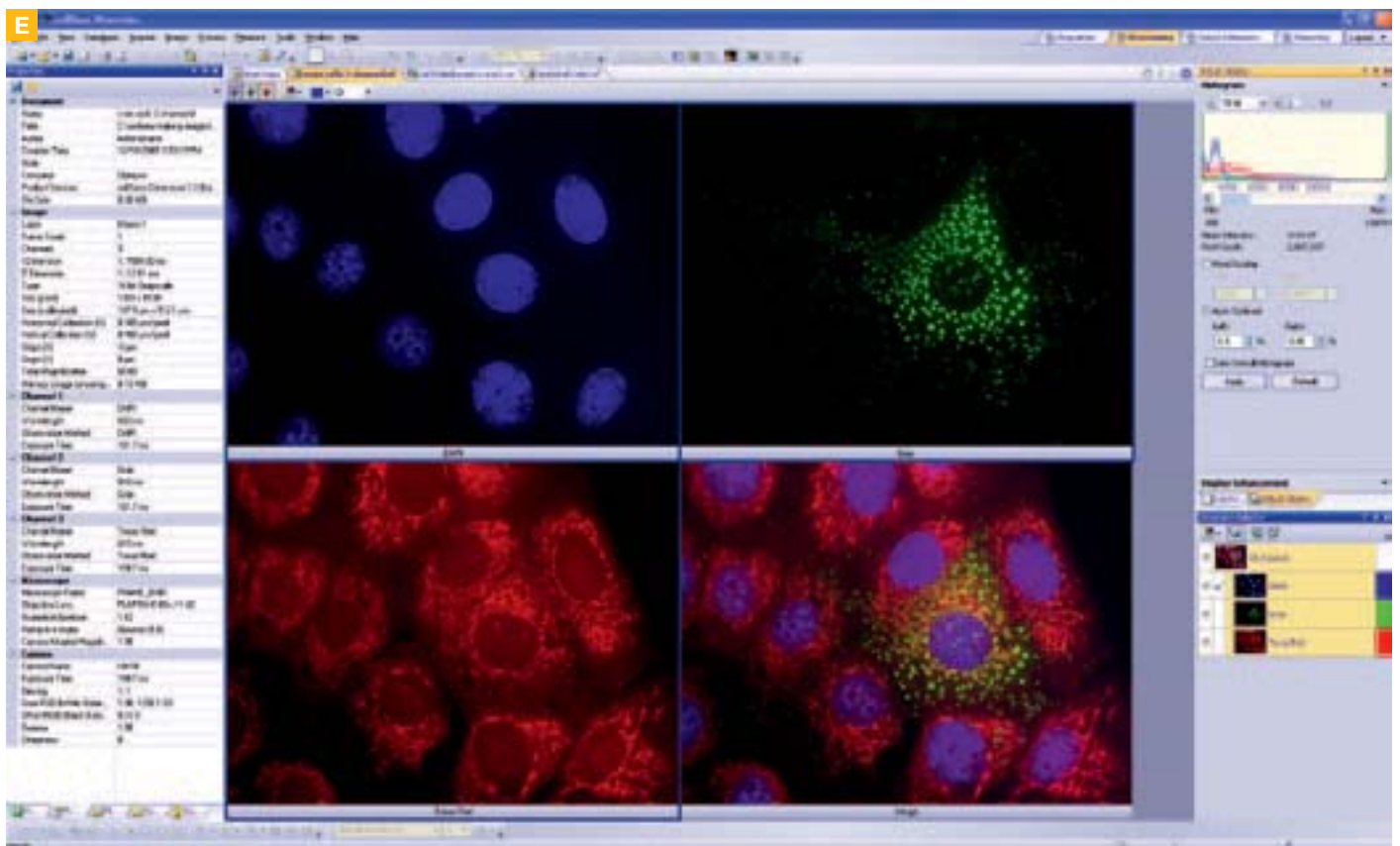

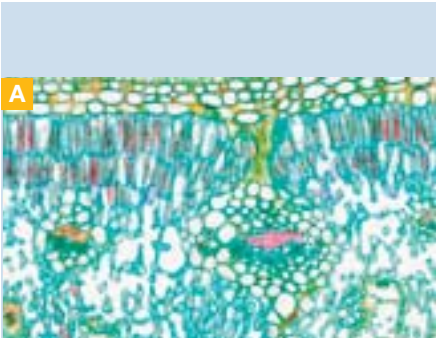

Brightfield: oleander leaf

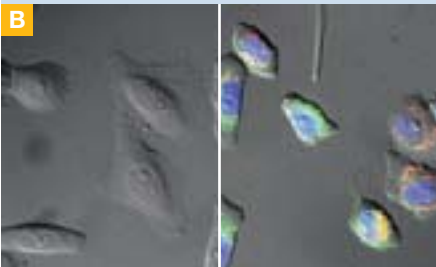

DIC: HeLa cells (right-hand side: DIC combined with fluorescence)

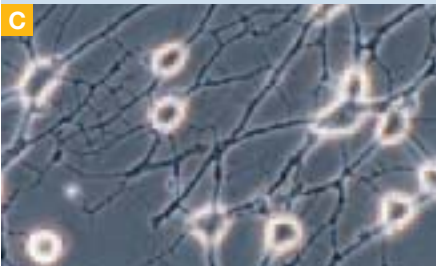

Phase contrast: astrocytes



Polarisation: crystals



Darkfield: diatom (*Arachnoidiscus ehrenbergi*)

CONTRAST – TO SEE OR NOT TO SEE

At the microscopic level, biological samples tend not to possess inherent contrast, such as colour variations, when using standard brightfield illumination. As a result, a number of different ways of generating contrast have been developed. These can be split into two parts: optical contrast methods and sample contrast methods. Whatever the source of contrast, the Olympus BX3 range and UIS2 optical components perform peerlessly, providing sharp and clear images.

Optical contrast methods

DIC

B DIC, phase contrast, darkfield and polarised light all rely on the management of light to produce distinct images. Of these, DIC provides the finest morphological detail by introducing contrast in essentially transparent specimens, rendering differences between features as height information. Olympus has developed three DIC solutions: High-contrast DIC is ideal for thick samples such as *Caenorhabditis elegans* where multiple cell layers can hinder clarity by producing unwanted noise and glare. High-resolution DIC is aimed at low-contrast specimens such as thinly spread cells on a slide, where the sample possesses very little contrast. The universal DIC solution balances the effect for samples where there is a wide variation in sample thickness, such as tissue slices.

Phase contrast

C Phase contrast is the standard method used to observe cells in culture and has the capabilities to visualise dynamic events. In effect, the phase contrast technique employs an optical mechanism to convert minute variations in phase shift in the light passing through transparent specimens into corresponding changes in amplitude, which can be visualised as differences in image contrast.

Polarised light

D Polarised light can be used to illuminate birefringent samples, within which the various features alter the polarisation differently, leading to visible contrast.

Darkfield microscopy

E Darkfield microscopy is different again: samples are illuminated obliquely, such that no directly transmitted light is observed. Instead only light that has been significantly refracted by the sample is collected and visualised.

Sample contrast methods

F G Offering greater flexibility than traditional immunohistochemistry (IHC), fluorescence microscopy has become an extremely important technique in the advancement of science and medicine, and in 2008 the Nobel Prize in Chemistry was awarded for the “discovery and development of the green fluorescent protein, GFP”. Fluorescence microscopy not only includes a range of basic and advanced imaging protocols, but also complete experimental procedures. In brief, fluorescence dyes emit light of one wavelength once excited by a slightly shorter wavelength. As a result, a microscope system has to provide the perfect excitation and emission properties, which is where the UIS2 optical system comes into its own. With high transmission from UV to IR and broad aberration correction, as well as low auto-fluorescence, a full range of fluorescence protocols can be completed on the BX3 microscopes.

One microscope – many functionalities

H Whatever the imaging methods used, the Olympus BX3 microscope range and UIS2 optics can be combined with the correct arrangement of filters, polarisers, condensers and prisms to ensure high-level imaging every time. Add the flexibility and dependability of the Olympus microscopy digital imaging cameras, illuminators and cellSens software family, and a whole new world of imaging and analysis emerges.

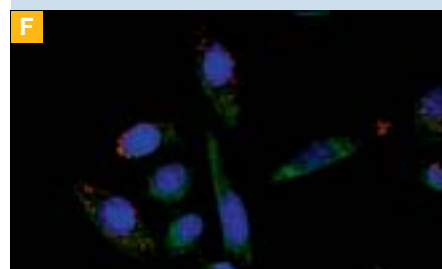

Multifluorescence: HeLa cells

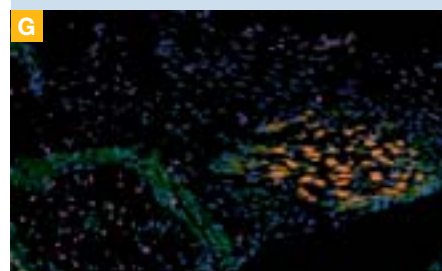

Multifluorescence: Axolotl

Image courtesy of Eugeniu Nacu and Febriyani Damanik, Tanaka lab, Center for Regenerative Therapies Dresden (CRTD), Germany



A Olympus UIS2
Superior optical system

UIS2
World-leading optics

B UPlanSApo
Spectral apochromat objective



C UPlanFLN
Plan fluorite objective



D Fluorescence condensers
Manual, encoded and motorised versions



OPTICALLY AHEAD OF THE CURVE

At the heart of any light microscope is the optical system; a series of lenses, prisms and filters designed to magnify the target area of a sample whilst resolving it in more detail. This is far more complex than this basic overview portrays since, as well as enabling samples to be imaged, the optical system allows the introduction and control of light and the projection of images to the eyes (or to a camera). On top of all of this is a range of optical aberrations that can affect microscopy if not properly corrected. The Olympus UIS2 optical components have been developed to provide the perfect optical system, setting a new standard in precision and clarity.

Perfect in every way

A The Olympus UIS2 optical system is more than just a range of objectives and filters. It is an optical concept developed specifically for microscopy, with an extensive number of features balanced perfectly with the requirements of the application, be that routine or highly original and groundbreaking science.

Spectral apochromat and fluorite

B C Life science researchers will benefit from the extensive fluorite and exquisite spectral apochromat (SAPO) objective series. The Olympus UIS2 fluorite objectives provide high quality across the extensive range. The spectral apochromat objectives represent the cutting edge in high-end microscope optics. They fully compensate for both spherical and chromatic aberrations (including Z-shift) from the near-UV to the near-infrared regions. Furthermore, the consistently high numerical apertures (NAs) of the SAPO objective range ensure the maximum possible resolution at each magnification. As a result, the Olympus fluorite and SAPO objectives offer unbeaten quality and performance for every kind of imaging.



PEERLESS FLUORESCENCE

Olympus UIS2 optics are particularly well suited to fluorescence imaging, ensuring the entire optical path – from the sample to the imaging device or eyes – is optimised for multi-wavelength analysis.

Keeping signal high and noise low

D – F By using carefully selected raw materials for the glass and applying advanced ultra wide-band (UW) multi-coatings technology, Olympus has greatly reduced the autofluorescence associated with the optical components and thereby significantly improved the S/N ratio. Numerical apertures have also been maximised across the entire series of UIS2 objectives to ensure that as much signal as possible is collected from the sample. Furthermore, the advanced Olympus immersion oil has been engineered to have very low autofluorescence for superb contrast and optimised viscosity for maximum ease of use. Moreover, Olympus quality standards guarantee minimal batch-to-batch variations over the entire product range. As a result the Olympus UIS2 system provides flawless fluorescence for all steps in the process: excitation, emission signal collection, magnification and image capture.

As well as the objectives, the new UIS2 fluorescent mirror cube range and 8-position fluorescence condensers have been optimised for flexible and high-quality imaging. An ultra high-quality coating process provides excellent transmission and exceptionally steep cut-off slopes, and the low-reflection interior surfaces eliminate over 99% of stray light. As a result, these filter cubes ensure maximum transmission and superb colour separation, which, coupled with the low autofluorescence glass materials, further improves the S/N ratio. In addition, the mirror cubes can be exchanged without the need for any tools, making updates very quick and easy.

Flat field with high transmission

F G Olympus UIS2 objectives not only yield flat images across the entire field of view (FOV), but also minimise Z-shift between different wavelengths. These, coupled with high transmission over a wide wavelength range (from UV to IR), ensure superb performance for even the most complex multicolour fluorescence microscopy.

Homogenous illumination

H It is important to ensure that the field of view is illuminated homogeneously. The nature of fluorescence illumination makes this a difficult task, but Olympus has developed the ultimate solution with its unique fluorescence illumination concept, which incorporates a novel fly-eye lens system. As a result of this advance, not only are users assured of flawlessly homogenous illumination across the entire wavelength spectrum, but they also have the benefit of much simpler burner alignment.

F Transmittance

UIS2 and conventional objective

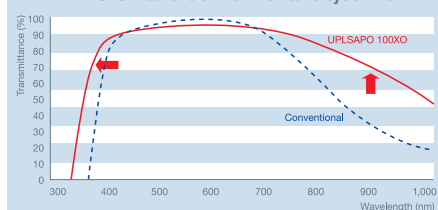

G Chromatic aberration

UIS2 and conventional objective

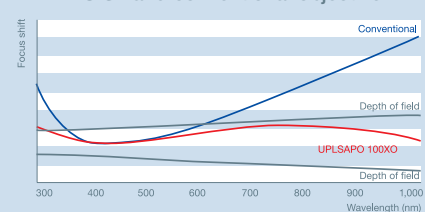

Fly-eye lens for homogeneous fluorescence illumination

A Typical construction Of a high-performance LED

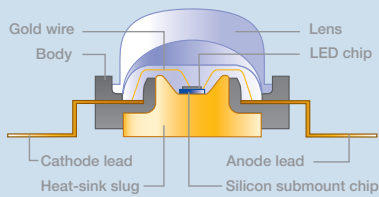

B Spectral characteristics Of different light sources

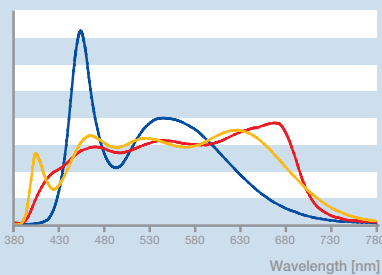

- Conventional white LED
- Halogen lamp + daylight filter
- BX3 true-colour LED

C True-colour LED Excellent colour rendering



D LED lamphouse Featuring advanced mixed-matrix brightfield LED technology



ILLUMINATION CHAMPION

Light is always required for optical microscopy – even for the so-called dark-field technique. But providing effective illumination for the various microscopy techniques isn't as simple as shining a light at a mirror under the sample! Modern microscopy requires dedicated illumination solutions matched to the needs of the application, including the unique requirements of fluorescence imaging. The Olympus BX3 leads the way with its illumination solutions.

The future of brightfield

A – D Even with the advent of highly advanced fluorescence microscopy techniques, brightfield observation is still the most important procedure in everyday microscopy. Olympus is taking brightfield to the next level with the most advanced mixed-matrix brightfield LED technology currently available. This new true-colour LED has been designed to provide a colour rendering index very similar to that of halogen bulbs with daylight filters. This means that stain colours appear exactly the same under the true-colour LED as they do under daylight filtered halogen, and also that similar (but not identical) colours can be clearly differentiated. Such clarity cannot be provided by standard LEDs as they cannot provide the same colour rendering capabilities and diagnostic imaging thus becomes difficult. This advanced colour rendering technology therefore provides a wavelength range ideal for the most commonly used stain colours – purple, cyan and red (e.g. haematoxylin and eosin – HE).

Benefits

This not only provides optimum continuity when moving to a new microscope, but also a number of other clear benefits. These include precise intensity control by simply varying the voltage, since LEDs provide the same colour temperature whatever the intensity. Halogen bulbs vary greatly as the power input changes and therefore rely on ND filters to vary the illumination intensity. Furthermore, the LEDs require very little power and have excellent longevity, greatly exceeding the lifetime of all other light sources and making them almost maintenance-free. As a result they provide very low running costs and are much more environmentally friendly at every stage.

Traditional illumination

For high-power illumination, the BX53 and BX63 microscopes can be fitted with a 100 W halogen lamp providing the flexibility for all contrast methods including differential interference contrast, which requires an increased amount of light.

Here too, Olympus has made improvements with the new Eco Function: A sensor monitors the presence of the user whilst the halogen bulb is turned on. If the user is away from the microscope for more than 30 minutes, the unique Eco Function turns the bulb off, reducing unnecessary power consumption and increasing bulb life.

Condensers

E F Olympus has developed a range of UIS2 condensers to suit every possible application, ensuring that illumination is optimised for each and every process. In addition, standard and motorised 8-position universal condensers provide excellent system versatility and allow various kinds of transmitted light observation from brightfield to phase contrast, darkfield, polarisation and DIC.

With the motorised model, switching between these observation methods is vastly simplified, since top-lens, optical elements, the polariser and the aperture stop are automatically put in position according to the selected observation method. In fluorescence the condenser moves to an in-between shutter position and the aperture stop is closed, thus minimising background noise and improving the signal-to-noise ratio (S/N).

E Motorised condenser

Enables contrast management



F Automated 8-position condenser:
excellent system versatility.



A Next-generation arc burner Alignment-free

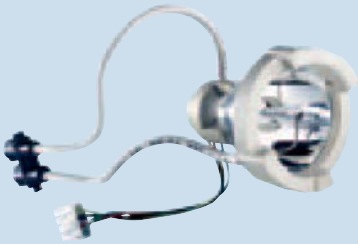

B X-Cite 120PC Metal halide fluorescence illumination system

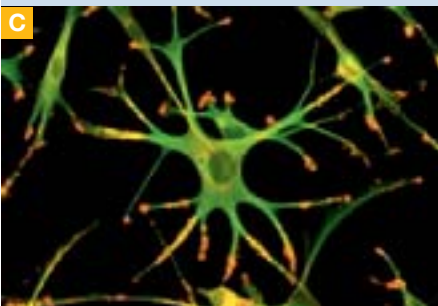

N115 cells, stained with FITC and Rhodamine

FLUORESCENCE ILLUMINATION

As noted above, the UIS2 optical system is designed to provide the best possible fluorescence light handling and transmission. The BX3 system concept incorporates a range of fluorescence illumination units, including an LED module, to provide the correct platform for each application. At the core of the BX3 microscope's fluorescence capabilities is the new fly-eye lens system, which combines brilliantly with the new 8-position filter turret and advanced high-transmission, low-noise filter cube design to provide unmatched fluorescence illumination quality.

A modern illumination concept

F – H Fluorescence illumination has been at the forefront of life science microscopy for many years. With the BX3 systems, Olympus has incorporated a number of design features and components that will enable fluorescence to maintain this leading position. Of these advances the most important is the introduction of a novel fly-eye lens system which ensures that the field of view is illuminated homogeneously, both in terms of fluorescence intensity and wavelength. As well as providing such flawless illumination, the fly-eye system also provides much easier burner alignment.

Arc burner brilliance

A B The BX3 frame supports the direct attachment of 100 W mercury, 100 W mercury apochromat and a 75 W xenon apochromat lamphouses, which provide easy alignment and straightforward operation. The BX3 range also provides the perfect platform for the more advanced EXFO X-Cite arc burner range, including the *exacte* model. These peerless modules provide the same fluorescence spectrum and similar intensities to standard mercury burners, but ensure an additional level of consistency and safety, making them excellent options for a broad range of requirements. The X-Cite range uses alignment-free metal halide burners and the unique metal halide technology ensures much of the tungsten eroded during “burning”, is recycled back to the electrodes. This slows down the widening of the arc gap, which in turn decreases the rate of intensity reduction. This, coupled with the electronic control gear (ECG), which ensures that as the gap between the electrodes grows the correct voltage is used to generate a consistent arc, greatly extends the life of the burner.

Better burner, better safety

The unique IntelliLamp™ system monitors and maintains the optimum lamp temperature to ensure consistently safe operation and even prevents hot-striking. Lamp usage is tracked and the ECG system ensures that lamp voltage is regulated to compensate for intensity loss over lifetime, and once the voltage reaches an upper limit it shuts the system down safely, greatly decreasing the risk of dangerous lamp explosions.

Stability in both the short and long term

The X-Cite *exacte* takes mercury burner technology one step further with the addition of a unique calibration system and closed-loop feedback stability technology. The calibration unit ensures that light output can be calibrated in absolute (watts) or relative (%) units, ensuring that research is truly repeatable. Closed-loop feedback constantly monitors the light output, adjusting the iris to ensure that any small changes are compensated for. Further advances in the *exacte* model include a DC-powered burner for more stable lamp output, a 100-step (1% increment) intensity adjustment, a pre-light guide bandpass filter to remove deep UV and IR wavelengths, a high-speed shutter, TTL and USB inputs and a light guide detection safety feature.

GROUNDBREAKING LED FLUORESCENCE

LEDs can be designed to emit light within defined wavelength bands, enabling very precise excitation of fluorescent dyes. Excitation wavelengths can be switched much faster with LEDs than with any mechanical wavelength switching system. Experiments employing multiple excitation wavelengths to analyse cellular dynamics, e.g. FRET, will benefit directly from the increased time resolution. LEDs can also be switched on/off very quickly, resulting in maximum specimen protection. Furthermore, LEDs offer excellent lumen maintenance over their entire lifetime. This means that during an experiment (however long) the light intensity will hardly change, which means that LEDs provide highly reproducible results and the ability to be fully quantitative.

Command and control

D E For the precisExcite fluorescence LED system, 20 different LED array modules (LAMs) are now available, enabling up to four wavelengths to be controlled at once. precisExcite is also the first LED fluorescence system to feature an exact 490 nm wavelength module, which is perfect for experiments using FITC. precisExcite is the only LED illumination system on the market to use specially developed, proprietary LED array design optimised for microscopy and a cooling system which enables it to attain intensities not possible on other systems.

Delicate and defined

With LED illumination come two very important benefits for fluorescence applications: the reduced phototoxic effect on living specimens and the reduced tendency for bleaching. These are possible as the LEDs emit light with very defined wavelengths and can be switched on and off very quickly, ensuring that specimens are only illuminated for the amount of time needed for the protocol.

D precisExcite

High-power fluorescence LED illumination system



precisExcite LAM: the brightest fluorescence LEDs currently available

F

Conventional Köhler illumination

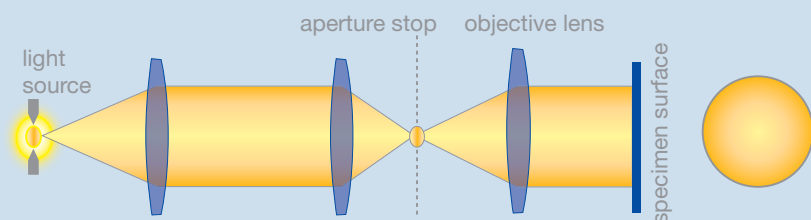

Illumination with fly-eye lens system

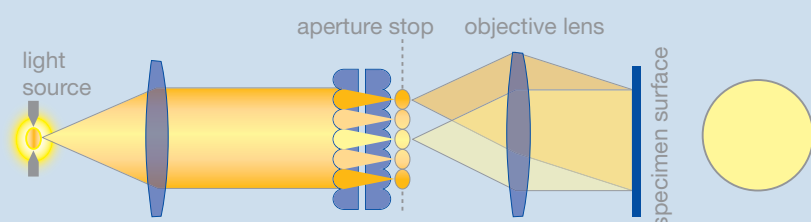

G

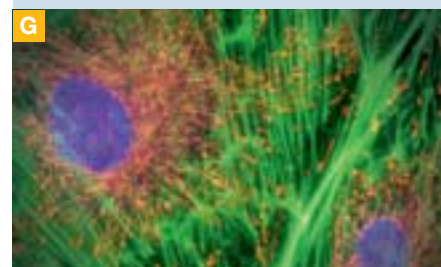

Bovine pulmonary artery endothelial cells, uneven illumination

H

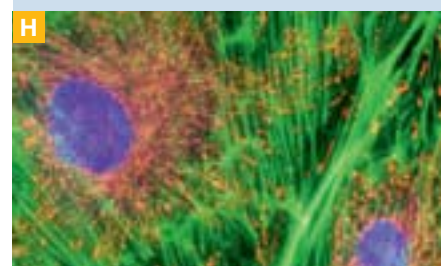

The same image with fly-eye lens illumination system



THE SYSTEM IS YOU

A plethora of possibilities

Often, systems can be inflexible and designed to complete a single task, but the new range of Olympus microscopy and imaging products provides systems that are the complete opposite – designed for your personal requirements with excellent flexibility. As a result, you have complete control of every aspect of your system from workspace layout and automation to image capture and software workflow.

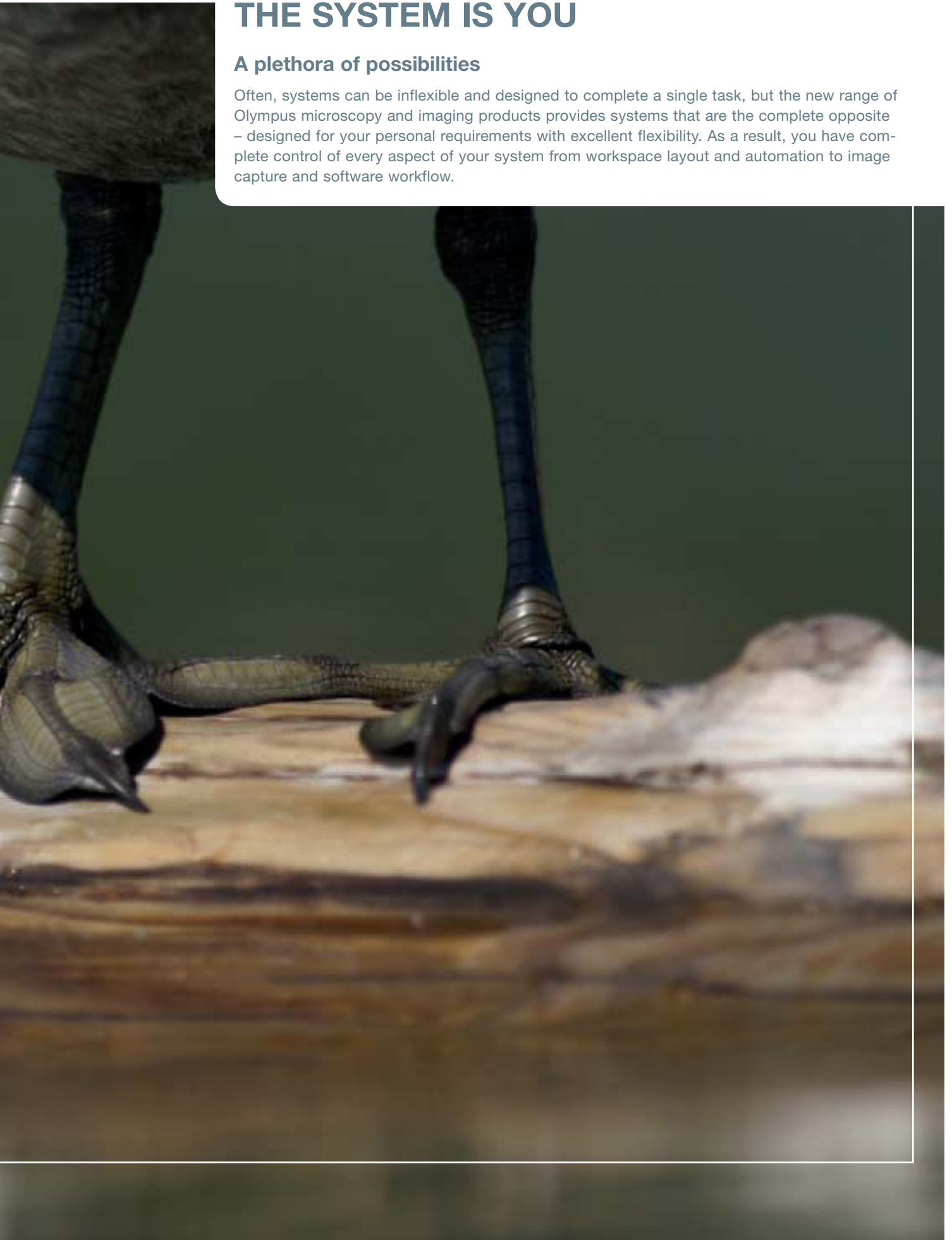

A BX53 microscope

With motorised components

**B** Motorised nosepiece

Seven positions

**C** Motorised condenser

Enables contrast management



MOTORISATION: PUSHING THE BOUNDARIES

The Olympus BX3 microscopes offer even greater application flexibility via a series of motorisation and automation options, all of which can be controlled, along with illumination and image capture via the cellSens software. The addition of these motorised and automated components therefore provides excellent potential for enhanced experimentation.

Magnification

B Motorising the nosepiece has the advantage that the objective can be changed using either the remote control handset or the PC software control. This makes imaging far more efficient, freeing the user up to perform other tasks. Also, the more advanced imaging techniques may require the use of multiple magnifications and, with a motorised nosepiece and cellSens software, the whole process can be automated. A further benefit is that the correct objective is selected every time and the magnification is recorded with each image. If motorisation is not required but automated detection of the objective is, the coded nosepiece provides an exact solution for this, ensuring the correct scalebar is added to the image and that the magnification is recorded fully in the metadata.

Contrast

C Changing transmitted light observation methods means ensuring correct arrangement of ND filters, polarisers/analysers and condensers on top of using the correct objectives. For situations where a single user or group of users change techniques very regularly, Olympus can provide motorised components to ensure the proper management of contrast. The 8-position universal condenser even controls the top lens to ensure the full magnification range is available. The condenser guarantees that optical elements such as DIC prisms, phase inserts and polarisers can be selected easily. To ensure that the illuminating light is as closely matched to the objective as possible, the aperture stop is automatically set based on the NA of the objective in use. Importantly, it is sometimes necessary to automate these changes and here the Olympus cellSens software further increases efficient contrast management.

Flexible wavelength selection

D E With the ever-increasing number of fluorescent dyes, more researchers are in need of efficient fluorescence microscopes, but do not always need everything motorised. One of the core components to motorise is the mirror turret. As a result of the increasing number of fluorescence dyes, experiments have become more complex and can utilise various dyes at once. MFISH (multiple fluorescence *in situ* hybridisation) for instance, can use up to five fluorescent probes in one specimen. Therefore it is important that the microscope can not only switch between the different dichroic mirrors and filters quickly, but that it can also hold enough to make use of a broad range of dyes. Olympus has therefore incorporated optional 8-position motorised mirror turrets into its BX3 microscope range.

Coordinated components

F Being able to motorise multiple components ensures that both routine and complex imaging techniques can be automated. For example, many fluorescence images are displayed alongside a DIC version to integrate functional (fluorescence) with morphological (DIC) data. Capturing this requires the correct transmitted light and optical components to be in place for the DIC image and then changing light sources and condensers, adding the correct reflected light filters and dichroic mirrors for the fluorescence image, as well as taking the images. There may also be multiple fluorescence images to be taken, necessitating further filter and mirror changes. Automating this makes it very quick and easy to perform, leaving the researcher more time to study their results. A coded fluorescence illuminator is also available to enable manual selection with automated detection of which filter cube is in the light path. As a result, image metadata is automatically and securely stored.

On stage

Another component that can be motorised is the X Y stage. This not only enables easier sample navigation, but also advanced imaging processes. For example, using the cellSens software a user can navigate a sample and set multiple areas of interest to be imaged, then determine what imaging techniques should be used for each (e.g. DIC and two different fluorescence wavelengths). The whole series of images will then be captured automatically without any further user input. Also, multiple overlapping neighbouring images can be captured and stitched together to provide a large, multi-field image in a process known as multiple image alignment (MIA). With a motorised stage, this process can be automated for high-speed imaging.

Software direction

With the cellSens software providing complete control over all of the motorised components, it is possible to run experiments automatically, greatly expanding the capabilities of the microscope system. For example, multidimensional imaging incorporating X, Y, Z, wavelength and time factors becomes straightforward, as does the acquisition of complex MIA and EFI (extended focal imaging) images. As well as the clear experimental benefits, there are additional advantages for the user in that there is much greater reproducibility and all of the associated metadata is saved correctly alongside the actual images.

D Fluorescence filter cubes

UIS2 optical system



E Motorised FL condenser

8 positions for fluorescence filter cubes



F Hand switch

Easy stand-alone operation



A BX63

Motorised microscope



AUTOMATION EXCELLENCE

Sometimes experiments can become very complex, or require experimental programming that reduces the amount of a researcher's time available for actually doing the experiment. In these situations, automating every aspect of the microscope enables the user to efficiently concentrate on generating the right data from each experiment and analysing it properly. This is where the BX63 comes into its own.

Hands-free

B – D The BX63 is supplied fully motorised and the user therefore does not need to touch the microscope except to place samples on the stage. The unique touch panel controller provides a programmable interface that can either be set to display only the functions relevant to the current observation technique (guidance mode) or display the full range of functions if required (full-operation mode). The motorisation components are also fully controllable via the cellSens software, which can fully automate the components for complex imaging tasks.

Hands-on

E For users that prefer hands-on control, the BX63 has an optional remote control unit that can be placed wherever the user requires it. For more traditional working the controls can be affixed to the front of the frame. This unit provides coarse and fine focus knobs, an X Y stage controller and push-button controls for objective and filter changes, etc.

Ultrasonic stage

F The Olympus BX63 features a new, high-precision, ultrasonic stage. Driven by advanced piezoelectric technology (as used in high-speed DSLR lenses in professional photographic cameras), the stage has a small form factor with silent and extremely smooth operation. It can also be physically positioned by hand, enabling rapid gross sample alignment. Via the high-precision built-in encoders, the stage provides true X Y coordination, enabling the user to set exact coordinates and navigate directly to them at high speed, even if the stage has been manually positioned. This new ultrasonic stage is also the basis for the automation of complex imaging procedures, such as MIA and multidimensional experiments, using the cellSens software packages.



F



Future focus – fixed stage

F The majority of upright microscopes are focused by moving the stage in the Z-axis. Stages and the drive machinery are relatively heavy and therefore can drift slowly out of focus. In addition, the stage can only be supported from behind as it needs to be able to move freely and this can lead to reductions in stage stability, which in turn affects image quality. The BX63 is uniquely focused by motorising the nosepiece in the Z-axis (possible due to the infinity-corrected optics) and fixing the stage to the rest of the frame at two additional points, making it extremely stable. In addition to this stability, the motorised nosepiece Z-drive is extremely accurate, enabling highly precise Z-stack capture and subsequent deconvolution.

Integrating modules

Along with the motorised microscope components, a full range of accessories is available and forms an important part of automated imaging systems. These include digital cameras and advanced arc-burner and LED-based fluorescence illumination systems. These add further flexibility to research imaging and can all be fully automated, providing smooth and efficient system integration. For example, all the settings for the Olympus digital microscopy cameras are controlled via the software, ensuring that the perfect image can be captured every time.

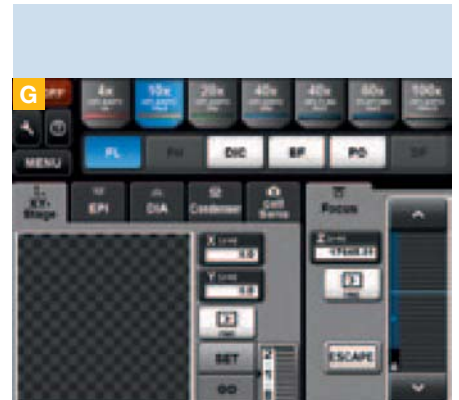

Full microscope control via touch panel user interface

CAPTURING EVERYTHING CORRECTLY

It is always preferable to have a choice, and this is definitely true when it comes to matching your digital imaging requirements with your project work. For brightfield applications you'll want dazzling colour fidelity and for fluorescence you'll need the perfect monochrome capture. There are also those occasions when you would like a microscope camera that can do both. Add to this selection the ability to pick from a range of image sizes and resolutions, and the Olympus digital microscope camera range really does offer you the flexibility of choice.

A Olympus True Colour

Colour management



B At one glance

The camera control tool window



Perfect colour fidelity

A Working alongside the Olympus true-colour brightfield LED, which provides the same colour rendering index as a halogen bulb with daylight filters, is the unique Olympus True Colour (OTC) digital imaging acquisition optimisation technology. Proving Olympus's commitment to overall colour fidelity throughout its microscopy and imaging systems, OTC ensures that the Olympus ultra colour (UC) and excellent colour (XC) microscope cameras present the colours in a sample with the highest possible fidelity. Similar capabilities are ensured via a specific processor board in the DP72 universal camera. The OTC system uses internal International Color Consortium (ICC) reference profiles to ensure consistency between the input and output colours at every stage of the imaging process. These profiles are even applied in live mode to ensure the best possible colour representation at the highest speed.

Enhanced functionality

B Once you have found the perfect image, the next challenge is to capture it accurately, but what if you need to alter the parameters? When using the Olympus cellSens software alongside your camera, all of the function controls that you require are situated on-screen next to the image. The Olympus Camera Control (OCC) enables effortless and flexible control of all aspects of acquisition, from the storage and retrieval of specific camera settings to direct access to advanced acquisition functions. Even the most complex imaging tasks become simple, making digital microscopy cameras easy for everyone to use.

The master of flexibility

C With the new Olympus DP72 camera there is no longer the need to compromise in any aspect of imaging. High sensitivity, speed, resolution and colour fidelity are all included in this groundbreaking colour and monochrome camera. With microscopists expecting ever higher resolution from their imaging systems, the DP72 does not disappoint. The outstanding 12.8-megapixel resolution will show your images in their finest detail, with natural colours as seen through the microscope eyepieces. The DP72 is therefore an excellent all-rounder suitable for a broad range of applications.

The colour specialist

D The Olympus XC50 colour camera offers a 5-megapixel resolution and is Peltier-cooled to provide a wide dynamic range along with a number of different frame rates using pixel binning and partial readout modes. These make the XC50 a versatile colour camera with excellent sensitivity and flexible operation. The 2,576 x 1,932-pixel CCD chip used in the XC50 offers 12 bits per colour channel and can be used for variable exposure times between 1 ms and 160 s. These features, as well as the high sensitivity, OTC colour fidelity, superior contrast and extraordinary signal-to-noise ratio, make the XC50 a great universal high-resolution colour camera.

The ultimate monochrome

E The Olympus XM10 monochrome camera offers all of the properties required to provide dependable fluorescence microscopy images: high resolution, extremely fine sensitivity, cooled CCD chip, variable exposure times and an optional external trigger function. The XM10 uses a 1,376 x 1,032 pixel CCD chip cooled to 10 °C (at 25 °C ambient) with a 12-bit dynamic range. It offers three binning modes: 2x, 4x and 8x, resulting in increased sensitivity and frame rates of up to 72 fps in live mode. This makes it easier to focus and locate areas of interest on samples while conserving highly sensitive fluorescence samples. At full resolution, the XM10 is ideal for all fluorescence acquisitions since it is extremely sensitive, low in noise and supports long integration times of up to 160 seconds. The XM10 is available with optional TTL trigger functionality and also in an IR-optimised version for fluorescence dyes in the infrared region. With an excellent balance of features the XM10 is ideal for recording all fluorescence images – from the brightest to the faintest signals.

Extended versatility

The Olympus BX3 microscope range is available with a broad range of camera adapters, offering the versatility to incorporate specialised imaging solutions that are not available from Olympus. For example, some experimental protocols require specialised cameras, such as electron-multiplying CCDs (EM-CCDs) or liquid nitrogen-cooled CCDs, which offer unique properties to maximise signal-to-noise ratios by enhancing photon collection or by eliminating electrical noise. Furthermore, video cameras may be needed for documentation in television programmes or films. Support for such third-party equipment is often also incorporated into the Olympus cellSens software, ensuring that integration into the whole system is seamless.

C DP72

Versatile high-resolution camera



D XC50

High-performance colour camera



E XM10

High-performance monochrome camera



F Centrabale camera adapter

Easy alignment of binocular observation and camera image



TOTAL SYSTEM CONTROL

A The three members of the cellSens software family – Entry, Standard and Dimension – all feature the peerless user-definable interface, but each one brings a unique level of functionality.

A cellSens software family
Solutions for your imaging tasks



B Without disturbance
Measurement lines and annotation text are kept on a separate layer

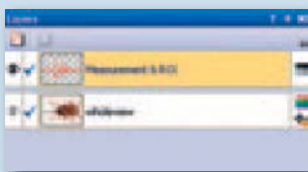

Results documentation – cellSens Entry

B cellSens Entry is the ideal stepping stone for researchers wanting to move into digital image acquisition and documentation. It provides control over all of the functions of Olympus's digital microscopy cameras including exposure time and pixel binning. Olympus cellSens Entry also supports live image acquisition in a number of different formats, including AVI movies, as well as live optimisation functions such as white balance, contrast optimisation and automatic adjustment of display settings. Olympus cellSens Entry integrates with standard Microsoft Windows systems, enabling images to be saved, retrieved, deleted and printed via familiar commands and interfaces, and the Windows Explorer pane can be included within any of the workflow areas. In addition, cellSens Entry can perform straightforward post-capture processing, and also includes layers technology for the addition of arrows and text annotations.

Experiment documentation – cellSens Standard

Olympus cellSens Standard builds upon the cellSens Entry package, taking acquisition beyond an image, by enabling more advanced image capture processes (e.g. time lapses). It also supplies multidimensional image-processing functions, along with additional image-enhancement tools and measurement capabilities and data export to Microsoft Excel for statistical analysis. Motorised components can also be controlled via cellSens Standard, enhancing image acquisition workflows.

Experimental systems – cellSens Dimension

The most versatile member of the Olympus cellSens software family is cellSens Dimension, which is designed to fulfil the control, processing and reporting requirements of integrated microscope-based experiment systems. As a result, it builds on cellSens Standard with a broad range of advanced features as well as specialised optional solution modules. The "My Functions" feature enables users to develop their own workflows for automating complex processes via a simple customisable tool window. Advanced imaging procedures such as extended focal imaging (EFI) and multiple image alignment (MIA) are combined with "online" features including greyscale deblurring and image browsing to provide excellent capture and processing capabilities. The Dimension package also includes noise-reduction filters and phase analysis functions, providing peerless image clarity and processing. Moreover, live images can be viewed remotely via a network, effectively turning the cellSens Dimension system into a webcam.

Olympus cellSens Dimension provides support for a wider range of cameras, as well as advanced fluorescence light sources including the EXFO X-Cite 120PC range and coolLED LED systems. The Dimension package also adds a range of image processing and analysis functions, including arithmetic and logical operations, edge detection, projection calculations and image smoothing. Intensity calibration can be carried out on each channel. What is more, with cellSens Dimension users can set markers on defined stage positions to include them in multi-position time-lapse experiments.

SPECIALISED IMAGING SOLUTIONS

The functionality of Olympus cellSens Dimension can be further expanded with a series of specialised Solution modules.

Multichannel 5D Solution

C The Multichannel 5D Solution for cellSens Dimension has been developed specifically for advanced, automatic acquisition of images combining any number of these five dimensions (5D): X, Y, Z, multichannel with transmission overlay and time lapse. As a result, this solution module conducts highly complex microscope experiments with multiple regions of interest. Colocalisation studies and spectral unmixing for overlapping fluorescence emission signals are easily performed, and there is full support for the Olympus spinning disk confocal unit. Furthermore, the user interface adjusts according to the needs of the image, so that only the required elements are displayed.

Multi-position Solution

D The Multi-position Solution module introduces automated MIA functionality for the rapid creation of panoramic images. It also makes it possible to capture images from multiple stage positions or entire stage areas. The module is designed to control a range of motorised stages from a range of manufacturers, including. Prior, Ludl and Märzhäuser.

Database Solution

E If large amounts of microscope imaging data are generated, it is important to be able to manage and search this effectively. The Database Solution module for cellSens Dimension adds a client-server database using Microsoft SQL 2005 Express Edition, ensuring that images and associated data and metadata are managed in a clear and controllable way.

Deconvolution Solution

F The Olympus cellSens Dimension Deconvolution Solution module uses a constrained iterative algorithm to remove out-of-focus blur, sharpening images so that researchers can extract more information from their images. The resulting impressive image stacks can be visualised with the powerful VoxelViewer that shows structures, iso-surfaces and projections. This is ideal for implementing consistent data structure and clear documentation routines.

Object Detection Solution

G The Object Detection Solution module adds efficient and precise threshold-based object detection, as well as classification. Additionally, the spectral unmixing tool emphasises the subtle differences in faintly stained samples.

C Multidimensionality

Easy configuration of multi-dimensional imaging tasks



D Multiposition Solution

Multi image alignment (MIA) for creation of panoramic images

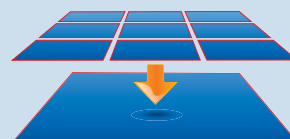

E Database Solution

For the control and handling of large amounts of data

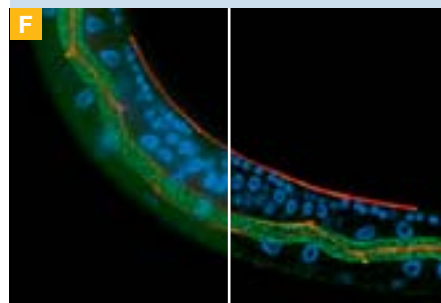

Comprehensive constrained iterative deconvolution: for crisp and detailed results

Image provided courtesy of Peter Gutierrez in Prof. Dr Alex Hajnal's laboratory at the Institute of Molecular Life Sciences, University of Zurich, Switzerland.

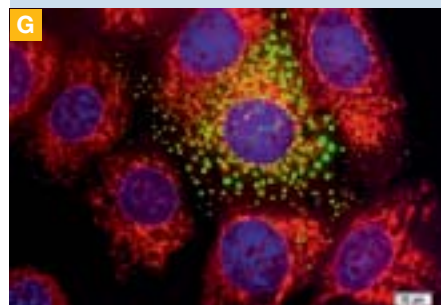

Retrieving figures out of images. Object detection gives reliable numeric data.

A Realtime online conferencing

Regardless of location



B Virtual Z

Scanning multiple Z-planes



VIRTUAL IMAGE: REAL MICROSCOPY

A Life science research has relied heavily on advances in microscopy to move our knowledge forward. The Olympus VS110 virtual slide system represents such a step forward, offering excellent throughput for extensive image analysis and superb documentation of tissue sections, cell cultures and even tissue microarrays. The VS110 system creates a virtual image of the sample at high resolution, enabling multiple researchers anywhere in the world to simultaneously navigate the file as if it were the actual sample.

Scan it right

With the VS110 you will be guided through the virtual slide acquisition process step-by-step by an intuitive scan wizard. This graphical user interface (GUI) features large control icons and enables even inexperienced users to immediately produce the perfect image results they require – in just a few steps!

View it right

B With the new VS110 you can scan multiple large specimens in multiple horizontal or Z-planes. Virtual Z allows you to simply focus through the specimen, as well as examine regions of interest in different dimensions. This enables better observation from any location, as well as the ability to discuss the sample with colleagues and peers whether they are local or remote. Furthermore, with improved contrast and image quality virtual slide images appear highly-defined and even clearer than before!

Access and security

The innovative, versatile Net Image Server (NIS) SQL expands the dotSlide capabilities with a client-server database and allows you to manage any kind of image in a simple and convenient way. What is more, the system is designed to work across multiple sites offering not only a local multi-site system, but also one that can be run throughout a region or around the globe. This powerful tool will enable your scanned images to be automatically uploaded to the database, making them readily available for immediate remote access and multiple-keyword queries. NIS SQL also supports multiple file repository systems to allow secure, easy networking between different scanning units within one database.

Multifunctional microscope

E The VS110 system comprises a research-level microscope with colour-perfect digital camera and advanced software. This means that it is not limited to function solely as a virtual slide system, giving great flexibility – especially where space and funding are at a premium. Furthermore, the microscope can be added to with a range of accessories, from new objectives to fluorescence illumination units.

Fluorescence

C D Fluorescent markers have become one of the main methods of generating clear contrast in light microscopy. What is more, they have allowed very specific identification of molecules, enabling ultra precise localisation and transport studies. The VS110 system can be used with fluorescent samples, giving a completely unique perspective – a slide recorded in full fluorescence that can be thoroughly examined without any risk of bleaching or damage to the cells.

Tissue microarrays

The VS110 is the ideal tool for tissue microarray (TMA) imaging. The system enables the acquisition of small tissue cores as single images, which can then be immediately uploaded together with the relevant metadata and overview of the TMA slide for traceability. As a result, it is easy to perform effortless analysis of the TMA and metadata, as well as to visually select a single core from the overview TMA slide image, giving you maximum versatility!

Specialised analysis

The VS110 software enables simple measurements such as circumferences, distances and areas without the need for scaling. With additional software tools, a number of analysis functions are available to aid in the rapid investigation of the virtual slides. For example, the cellSens Dimension software can be set to identify particles that fulfil a series of criteria such as size, shape and intensity.

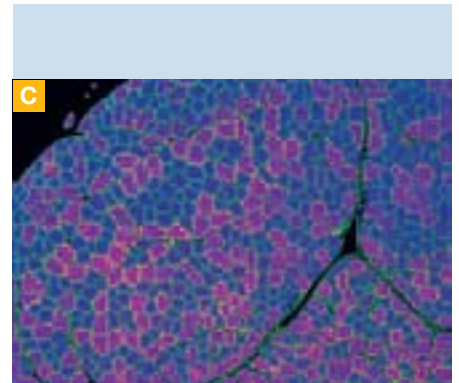

Section of a muscle

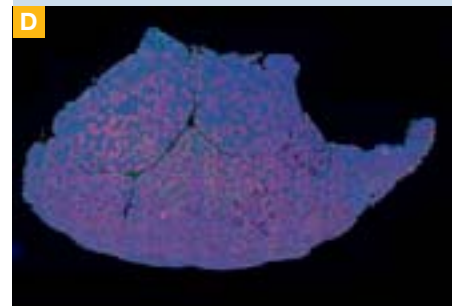

Section of a muscle, overview



BX3 Research Specifications

	BX53	BX63
Microscope frame		
Optical system	UIS2 optical system	UIS2 optical system
Focus	Coaxial coarse and fine focus with stage up and down mechanism	Motorised focus with objective up and down mechanism
	Focus stroke 25 mm	Stroke: 20 mm, minimum increment: 0.01 μm
	Coarse stroke 15 mm/rotation	Maximum nosepiece movement speed: 5 mm/s
	Fine stroke 100 μm /rotation	
	Graduation on fine focus 1 μm	
	Prefocusing limit stopper and torque adjustment on coarse focus	
Illuminator	Built-in Köhler illumination for transmitted light	Built-in Köhler illumination for transmitted light
	Light intensity LED indicator,	High colour reproductivity LED light source
	Built-in filters (LBD-IF, ND6, ND25)	Optional: 6 V, 30 W halogen bulb (pre-centred)
	12 V, 100 W halogen bulb (pre-centred)	
Revolving nosepiece		
	Interchangeable reversed quintuple/sextuple/septuple nosepiece	Interchangeable reversed quintuple/sextuple/septuple nosepiece
	Encoding optional with septuple nosepiece	Motorised septuple revolving nosepiece
	Motorised septuple revolving nosepiece	Encoding optional with septuple nosepiece
Observation tube		
	Widefield tilting, telescopic and lifting binocular, inclined -3° – 27°	Widefield tilting, telescopic and lifting binocular, inclined -3° – 27°
	Widefield tilting trinocular, inclined 5° – 35°	Widefield tilting trinocular, inclined 5° – 35°
	Widefield trinocular, inclined 30°	Widefield trinocular, inclined 30°
	Widefield erect-image trinocular, inclined 30°	Widefield erect-image trinocular, inclined 30°
	Widefield tilting binocular, inclined 5° – 35°	Widefield tilting binocular, inclined 5° – 35°
	Widefield ergo binocular, inclined 0° – 25°	Widefield ergo binocular, inclined 0° – 25°
	Widefield binocular, inclined 30°	Widefield binocular, inclined 30°
	Super widefield trinocular, inclined 24°	
	Super widefield erect-image trinocular, inclined 24°	
Stage		
	Ceramic-coated coaxial stage with left or right-hand low drive control, with rotating mechanism and torque adjustment mechanism, optional Ergo Grips available	Ultrasonic stage (stage stroke: X: 76 mm x Y: 52 mm), Maximum stage movement speed: 30 mm/s
	(Non-stick coated grooved coaxial, plain and rotatable stages are also available)	Ceramic-coated coaxial stage with left or right-hand low drive control, with rotating mechanism and torque adjustment mechanism, optional Ergo Grips available
		(non-stick coated grooved coaxial, plain and rotatable stages are also available)
		Cross stage with short left handle
Condenser		
	Swing-out achromatic condenser (NA 0.9), for 1.25x–100x (swing-out: 1.25x–4x)	Motorised universal condenser (NA 0.9, motorised 8-position turret, aperture stop, polarising filter in/out mechanism and top lens swing-out mechanism),
	Achromatic aplanatic condenser (NA 1.4), for 10x–100x	for 1.25x–100x [swing-out 1.25x–4x, with oil top lens: (NA 1.4)]
	Phase contrast, darkfield condenser (NA 1.1), [phase contrast: for 10x–100x, darkfield: for 10x–100x (up to NA 0.80)]	
	Universal condenser (NA 0.9), for 1.25x–100x [swing-out: 1.25x–4x, with oil top lens: (NA 1.4)]	Swing-out achromatic condenser (NA 0.9), for 1.25x–100x (swing-out: 1.25x–4x)
	Low-magnification condenser (NA 0.75), for 2x–100x (dry)	Achromatic aplanatic (NA 1.4), for 10x–100x
	Ultra low magnification condenser (NA 0.16), for 1.25x–4x	Universal condenser (NA 0.9), for 1.25x–100x [swing-out: 1.25x–4x, with oil top lens: (NA 1.4)]
	Darkfield dry condenser (NA 0.8–0.92), for 10x–100x	Ultra low condenser (NA 0.16), for 1.25x–4x
	Darkfield oil condenser (NA 1.20–1.40), for 10x–100x	Darkfield dry condenser (NA 0.8–0.92), for 10x–100x
	Motorised universal condenser (NA 0.9, motorised 8-position turret, aperture stop, polarising filter in/out mechanism and top lens swing-out mechanism),	Darkfield oil condenser (NA 1.20–1.40), for 10x–100x
	for 1.25x–100x [swing-out 1.25x–4x, with oil top lens: (NA 1.4)]	

BX3 Research Specifications

	BX53	BX63
Fluorescence illuminator	Manual reflected fluorescence, 8-position mirror turret unit, encoded, with tool-free exchange of filter cubes	Motorised reflected fluorescence, 8-position mirror turret unit, encoded, with tool-free exchange of filter cubes
	Motorised reflected fluorescence, 8-position mirror turret unit, encoded, with tool-free exchange of filter cubes	Manual reflected fluorescence, 8-position mirror turret unit, encoded, with tool-free exchange of filter cubes
Fluorescence light source	100 W Hg APO lamp housing and transformer	100 W Hg APO lamp housing and transformer
	100 W Hg lamp housing and transformer	100 W Hg lamp housing and transformer
	75 W Xe lamp housing and transformer	75 W Xe lamp housing and transformer
	Fibre-coupled metal halide light sources	Fibre-coupled metal halide light sources
	Fibre-coupled LED light source	Fibre-coupled LED light source
Controller	Optional: control box for semi-motorised set-ups	High-performance control box
Operating environment	Indoor use	Indoor use
	Ambient temperature: 5 °C to 40 °C (41 °F to 104 °F)	Ambient temperature : 5 °C to 40 °C (41 °F to 104 °F)
	Maximum relative humidity: 80% for temperatures up to 31 °C (88 °F), decreasing linearly through 70% at 34 °C (93 °F), 60% at 37 °C (99 °F), to 50% relative humidity at 40 °C (104 °F)	Maximum relative humidity : 80% for temperatures up to 31 °C (88 °F), decreasing linearly through 70 % at 34 °C (93 °F), 60% at 37 °C (99 °F), to 50 % relative humidity at 40 °C (104 °F)
	Supply voltage fluctuations: Not to exceed ±10% of the normal voltage	Supply voltage fluctuations: Not to exceed ±10% of the normal voltage

Dimensions

BX53 FL dimensions

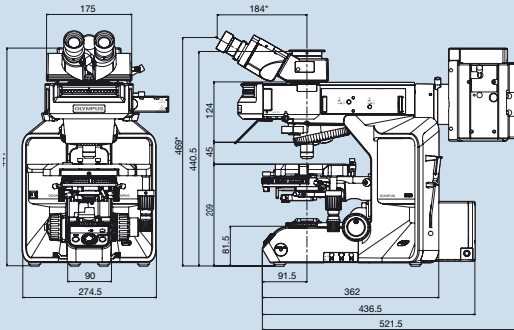

BX53 BF dimensions

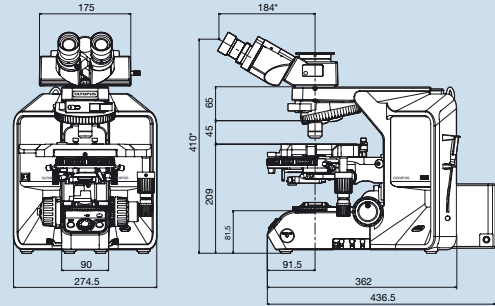

BX63 FL dimensions

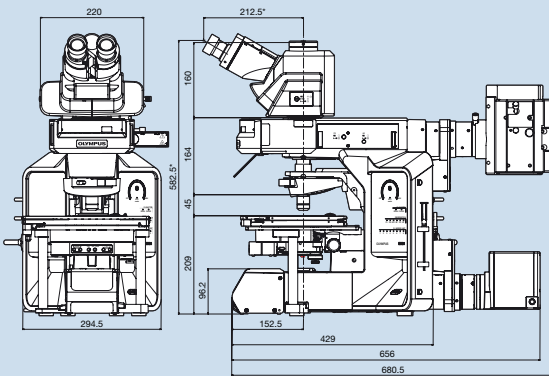

BX63 touch panel

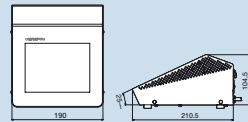

BX63 control box

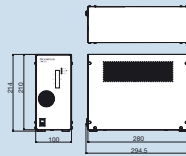

The manufacturer reserves the right to make technical changes without prior notice.

www.olympus-europa.com

OLYMPUS

ryf ag

 Ryf AG
 Bettlachstrasse 2
 2540 Grenchen
 tel 032 654 21 00
 fax 032 654 21 09
www.ryfag.ch