



# THE **NEW** moticam

2012 - THE NEXT GENERATION

*Moticams are the preferred accessory for small and medium professional labs around the world.*

**?** Did You Know?





2012 marks a new evolution in our Moticam range. For more than a decade, Motic has been leading the market in affordable, high quality Digital Microscopy solutions. The Moticams are known around the globe for their ease-of-use and their adaptability to a number of applications. Whether for Educational, Industrial or Clinical use, the Moticam's unique "All In One Box" design assures each user that this camera can fit almost any microscope.

With this new generation, we have listened to our fans from around the world and across a wide spectrum of users. This information has been distilled into the new 2012 range of cameras making them even more flexible, powerful and user-friendly than before. All this at more attractive prices than before.

At Motic, we believe in making quality Digital Microscopy affordable for everyone and we know that you will enjoy this new line.

# THE [AllinOneBOX] CONCEPT



At Motic, we strive to ensure that everything that you may need to attach the Moticam to your Microscope is included in one box. Supported by our own In-House team of Software and Mechanical Engineers, **each Moticam has the necessary equipment to help you turn your images into knowledge.** See what your Moticam box includes.



**An attachable camera** containing a sensitive professional imaging chip housed inside a C-Mount case including a removable IR cut-off filter.



**A focusable coated glass lens** matched to the size of the imaging chip.



**Two adjustable size Eyepiece Adapters** that allow you to attach the camera onto almost any microscope without having to remove the Eyepiece.



**A 4-dot calibration slide** with micrometer cross-hairs that ensure accurate calibration for accurate measurements.



**The Macro Viewing Tube** together with the focusable lens is great for using the camera without a microscope.



**All cables** and power supplies as needed are of course inside the box.



**A full version of Motic Images Plus application software** provides all tools you need to quantify, measure, annotate, teach, learn and much more. This software comes with unlimited updates and does not require any license fees

## **? Did you know?**

Each camera has a **standard tripod mount** so that you can secure your camera inside your own installation.

## Table of Contents

Moticam <b>1</b>	6
Moticam <b>1SP</b>	6
Moticam <b>2</b>	7
Moticam <b>3</b>	7
Moticam <b>5</b>	8
Moticam <b>10</b>	8
Moticam <b>580</b>	9
Motic Images Plus	10
Compatibility	12
Connect your Moticam	14

# Contents



# Moticam 1 & 1SP

Our range starts with the Moticam 1 series, which are great for Schools or Small Laboratories. With a live resolution of 800x600 or 1.3MP use these cameras with Interactive White Boards for exceptional integrated teaching. The live resolution along with great color-balance make these cameras an ideal and affordable introduction to Digital Microscopy across the board.

## Moticam 1 Specifications:

- Live Resolution: 800x600 pixels
- Sensor Type: CMOS
- Optical Calculation 1/4"
- Focusable Lens: 8mm
- Software Included: Motic Images Plus for PC and Mac
- Others: Driver installs automatically in Windows Vista and higher

## Moticam 1SP Specifications:

- Live Resolution: 1.3 Mega pixels
- Sensor Type: CMOS
- Optical Calculation 1/3"
- Focusable Lens: 12mm
- Software Included: Motic Images Plus for PC and Mac
- Others: Direct Show, TWAIN and Media Cybernetics Image Pro Plus 7 Driver compatibility



# Moticam 2 & 3

The Moticam 2 and 3 offer a great combination of high-resolution (up to 3MP) live imaging, while still remaining fast and affordable. Ideal for use not only in Colleges and Universities but also clinics and veterinary centers, these cameras offer something for everyone.

## Moticam 2 Specifications:

- Live Resolution: 2.0 Mega pixels
- Sensor Type: CMOS
- Optical Calculation 1/3"
- Focusable Lens: 12mm
- Software Included: Motic Images Plus for PC and Mac
- Others: Direct Show, TWAIN and Media Cybernetics Image Pro Plus 7 Driver compatibility

## Moticam 3 Specifications:

- Live Resolution: 3.0 Mega pixels
- Sensor Type: CMOS
- Optical Calculation 1/2"
- Focusable Lens: 16mm
- Software Included: Motic Images Plus for PC and Mac
- Others: Direct Show, TWAIN and Media Cybernetics Image Pro Plus 7 Driver compatibility

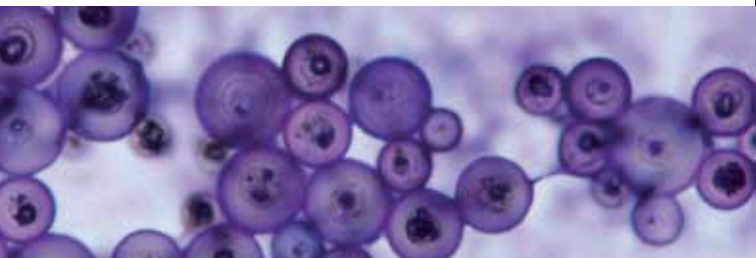

# Moticam 5 & 10

Do you require the ability for documentation? The Moticam 5 and 10 offer up to 10MP live and capture resolution. With such a high resolution range at your disposal, you can easily and professionally convert captured images into 300dpi documentation files. As with all our Moticam, both Moticam 5 and 10 contain our Rapid View algorithms allowing the user to display a faster frame rate at full-screen while still being able to capture an image at maximum resolution. This flexibility makes these Moticams a sound investment.



## Moticam 5 Specifications:

- Live Resolution: 5.0 Mega pixels
- Sensor Type: CMOS
- Optical Calculation 1/2.5"
- Focusable Lens: 12mm
- Software Included: Motic Images Plus for PC and Mac
- Others: Direct Show, TWAIN and Media Cybernetics Image Pro Plus 7 Driver compatibility

## Moticam 10 Specifications:

- Live Resolution: 10.0 Mega pixels
- Sensor Type: CMOS
- Optical Calculation 1/2.5"
- Focusable Lens: 12mm
- Software Included: Motic Images Plus for PC and Mac.
- Others: Direct Show, TWAIN and Media Cybernetics Image Pro Plus 7 Driver compatibility

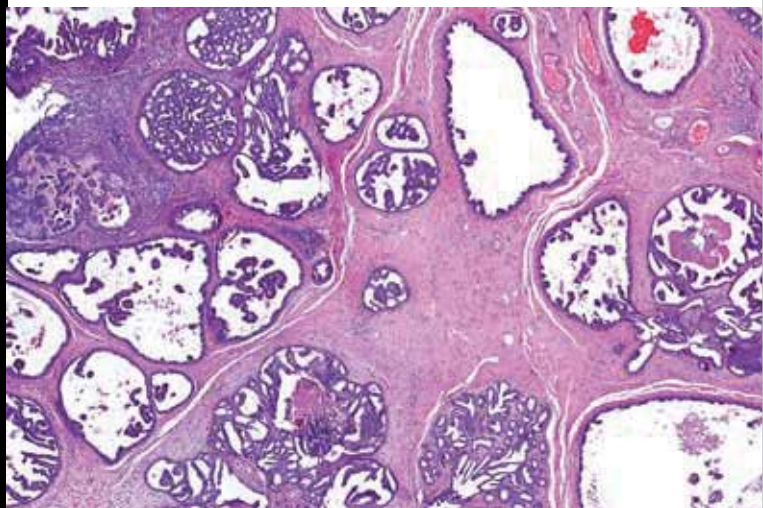



# Moticam 580

As an affordable multi-tasking microscopy camera, the Moticam 580 is in a class of its own. This camera does not require a computer for standard operation once it has been setup on a microscope. Images can be captured directly onto an SD card at 5.0MP resolution. Connecting it with a USB cable to a computer allows this camera to be used like any other Moticam with the supplied software. The 580's true versatility is underlined by its capability to display live images at 1080p resolution through the HDMI output port.

Whether used in an Educational, Industrial or Clinical area, the Moticam 580 is the Jack of all Trades in our new Moticam lineup.

**Multi-output** Connect your camera to a Computer, a Projector or an HD Monitor



## Moticam 580 Specifications:

- Sensor Type: CMOS
- Sensor Resolution: 5.0MP
- Optical Calculation 1/2.5"
- Focusable Lens: 12mm
- Output Possibilities: HDMI (1080p), SD Card (5.0MP), USB (800x600), Analog Video
- Software Included: Motic Images Plus for PC and Mac

# Motic Images Plus

**Motic Images Plus** for PC is a software suite that has evolved through more than a decade of close cooperation with end-users and professionals around the world. At Motic, we believe that actions speak louder than words, and this is why **a full version of Motic Images Plus is included in every Moticam box**. Once installed, you will not be asked to pay license fees or upgrade fees, simply register your Moticam online and get access to **free updates** when they become available.

Motic Images Plus consists of two main components, the Image Capture Interface (MI Devices) and the actual **captured image application program**.

**The Image Capture Interface** is a separate program through which the live image can not only be perfected with the multitude of adjustment features, but it can also be used as a teaching device thanks to its calibrated scale bars, grid and cross bars.

Capturing the perfect image is vital for all applications. For this reason, the **MI Devices interface** is also available whether the Moticam is used as a Direct Show or a TWAIN device. Whether you are using the Moticam in its easy-to-use Automatic mode or you are controlling each aspect of your image stream, this interface will satisfy all users.

Once the image has been captured it is automatically transferred to the Images Plus application program where Measurement, Annotation and Reporting Tools can be used to **turn images into knowledge**. With the proliferation of touch-screen monitors and interactive whiteboards, we have also optimized our interface to make it easier to use these technologies with our Moticams.

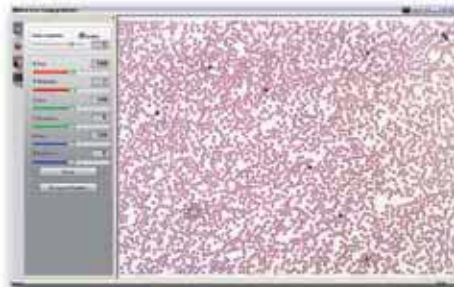

*MI Devices interface*



*MI Devices interface  
Video*



*MI Devices interface  
Color correction*



*MI Devices interface  
Adjustments*



*MI Devices interface  
Capture*



Motic Images Plus 2.0 - Measurements

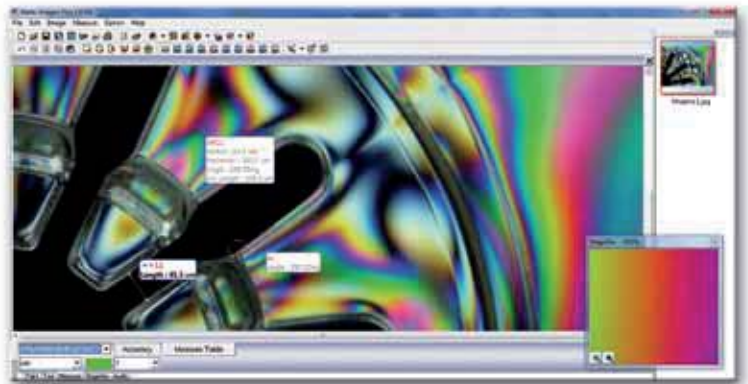

Motic Images Plus 2.0 - Measurements

# Compatibility

At Motic, we do our best to ensure that **our Moticams are compatible with the latest in technology available**. Currently all our cameras are compatible with **Windows XP and higher**. Most cameras are also compatible with **Apple's OSX** including Lion. If you are a Linux user, please ask us for our free Linux compatible software and drivers.

With our **Direct Show and Twain compatibility**, the Moticams can also be integrated into third-party application programs. The tools and services of our MI Devices interface are still accessible through **Direct Show and Twain**. In response to growing demand, Moticams are now able to be fully integrated into **Media Cybernetics' Image Pro Plus 7**. Please download the relevant plugin from the Media Cybernetics or Motic support pages.

For those who are interested in a little more advanced Digital Microscopy, our Moticams are also fully compatible with:

## MoticNet

Our comprehensive **multi-user observation and supervision platform**. Connect up to 100 digital microscopy stations together and supervise and control them from a single teacher's platform; hand out and collect homework and let an individual student take control of the class. **MoticNet puts the Teacher back in control**.

## MoticTrace

**Forensic imaging** does not have to be expensive. Simply connect up to four Moticams to a single computer and control simultaneous feeds from each camera. You can attach the cameras to your stereo or your compound microscopes and in a matter of seconds, you have created a **digital forensic comparison scope**. Digitally resize, overlap and rotate your feeds. This is a great tool not only for teaching forensics but also for the **first-level evidence processing centers**.



*Motic Trace*

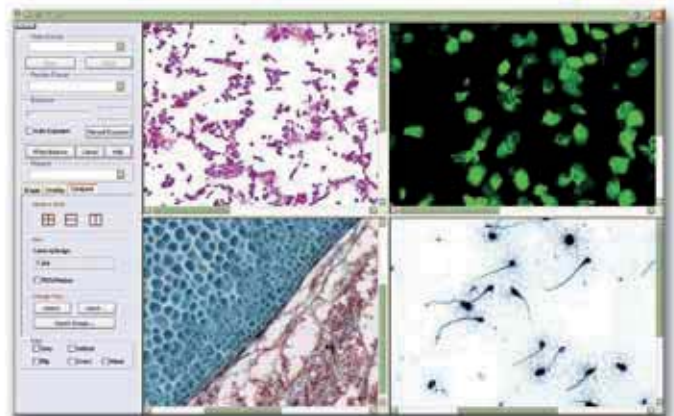

*Motic Trace*

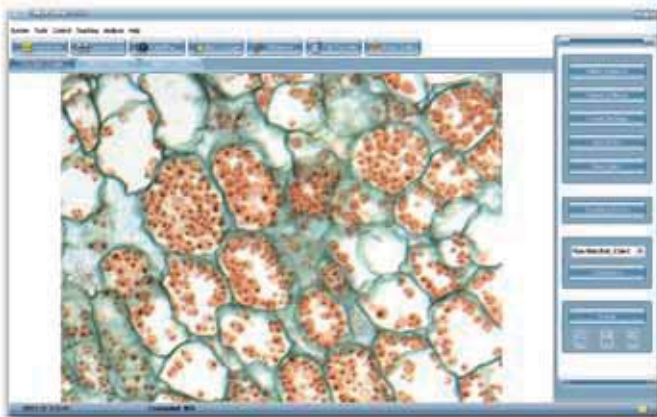

*Motic Net - Student*

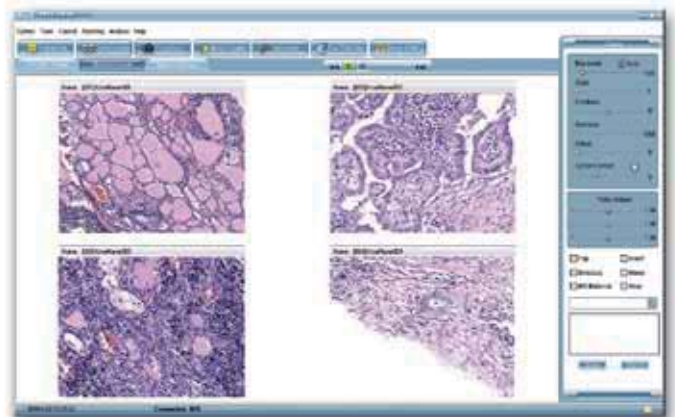

*Motic Net - Teacher*

# Connect your moticam Onto the eyepiece

With each **Moticam** we supply two eyepiece couplers (30mm and 38mm in diameter). Simply **connect the focusable macro lens to the camera and select the correct eyepiece coupler for your microscope**. Put the complete combination **onto the eyepiece**, and you have turned your conventional microscope into a **digital microscope**.

This solution is also applicable for non-Motic microscopes. In case of any doubts please contact your local **Motic** distributor.

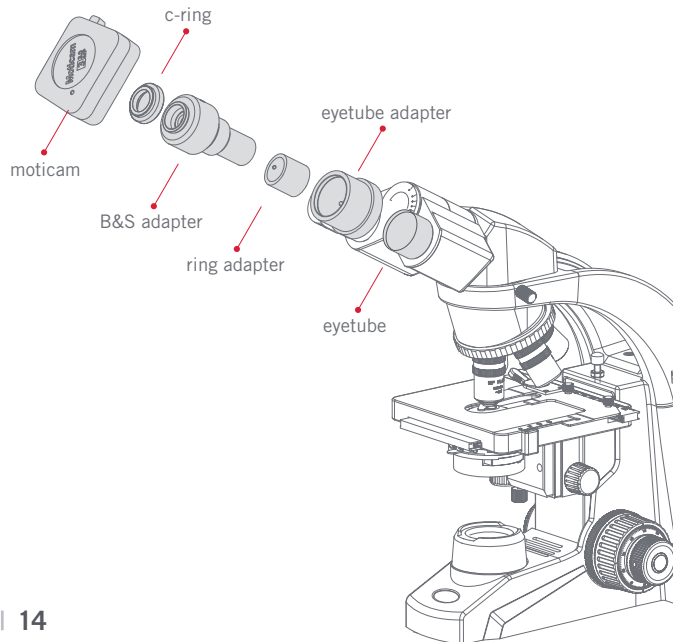
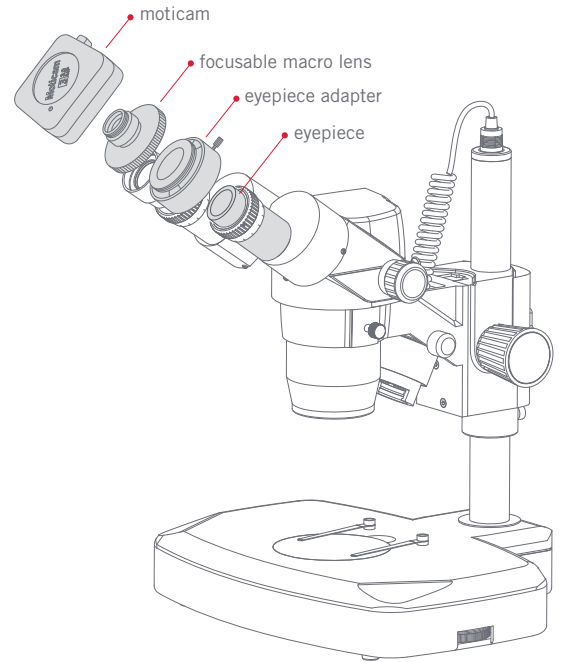

# Connect your moticam Into the eyetube

The special Eyetube adapter (B&S) is optional.

Simply screw the Eyetube adapter on the Moticam. Remove an eyepiece from the microscope and replace it with the **Moticam-Eyetube adapter combination**. You have turned your conventional microscope into a digital microscope.

This solution is also applicable for non-Motic microscopes. In case of any doubts please contact **Motic**.

# Connect your moticam

## Onto the trinocular tube

For all Motic trinocular microscopes we have several c-mount adapters available. The **c-mount adapter** needs to be chosen according to the chip size of the camera. Each **Moticam** (excluding the gooseneck cameras) comes standard with a CS/C-mount connection; the **c-ring** is included in the package.

Just fix the **c-mount adapter** on the trinocular port and connect the **Moticam** to the **c-mount adapter**. This combination will give you the freedom to continue observing with both eyes, while having the **Moticam** connected.

Our **Moticam** cameras can also be used on non-Motic microscopes, via the **universal c-mount connection**. Just remember that you will need the c-mount adapter from the manufacturer of your microscope.

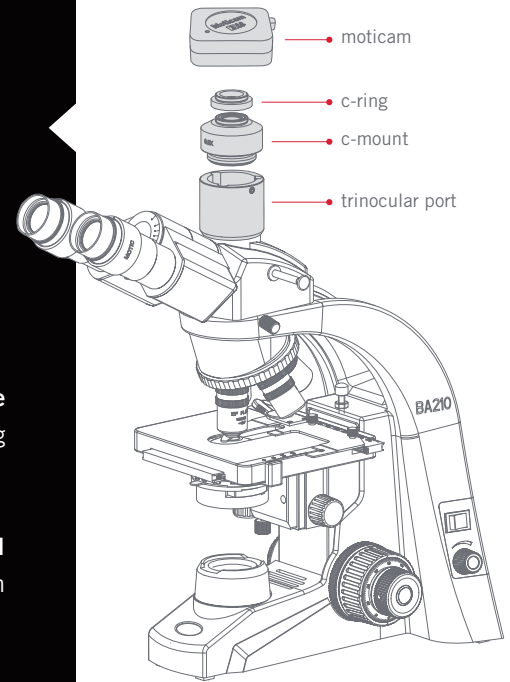

# Motic®



Canada | China | Germany | Spain | USA

ryf ag



Ryf AG  
Bettlachstrasse 2 · 2540 Grenchen  
t 032 654 21 00 · f 032 654 21 09  
[www.ryfag.ch](http://www.ryfag.ch)

microscopes · metrology · imaging