

Axio Scope
More Flexible. More Affordable.

ryf ag



Ryf AG
Bettlachstrasse 2
2540 Grenchen
tel 032 654 21 00
fax 032 654 21 09

www.ryfag.ch

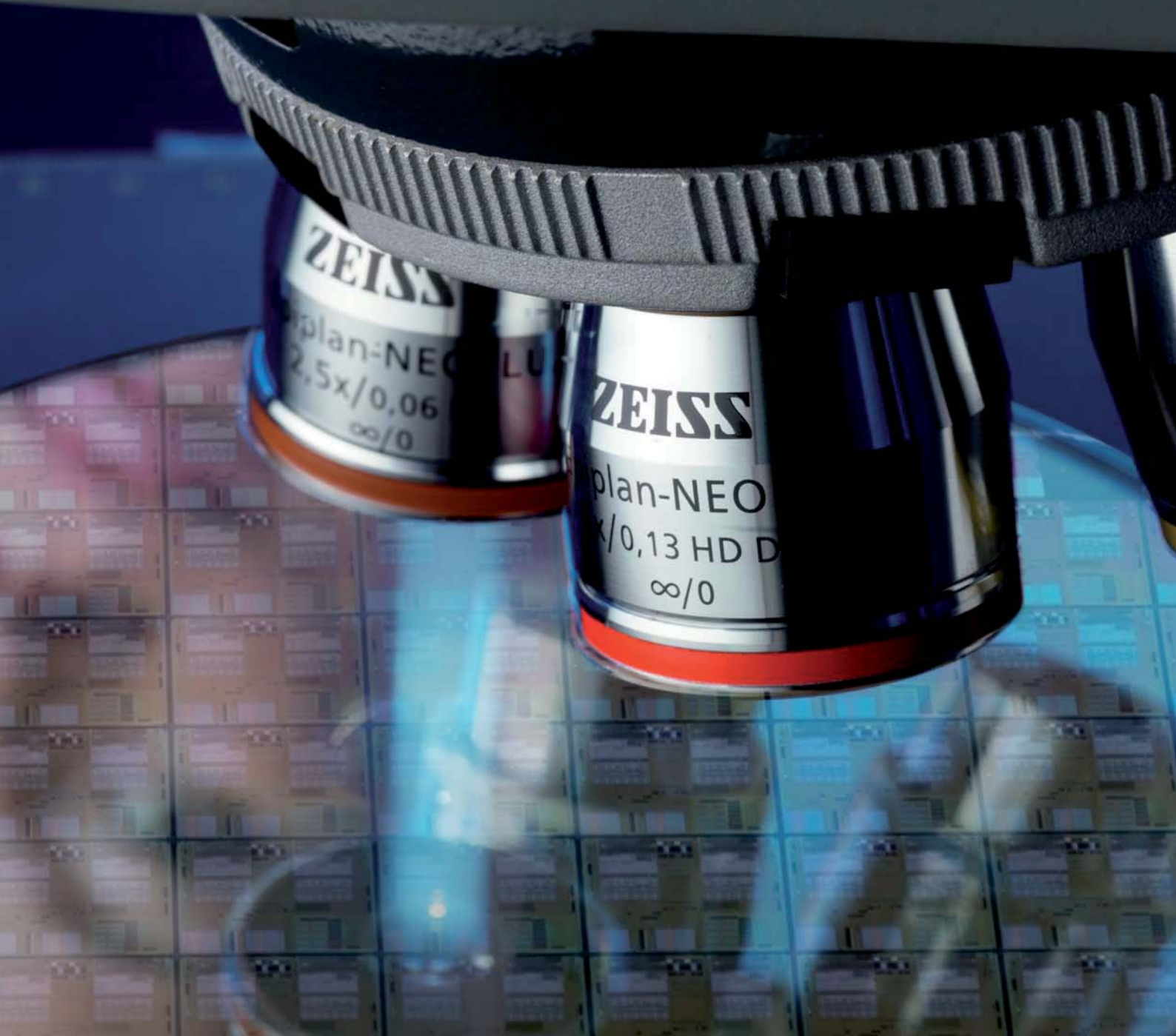

The Versatile Solution for
Routine Industrial Applications



We make it visible.

Ahead in Performance

More flexible in every component. More economical in every configuration. Axio Scope is your microscope down to the last detail.

Modularity has always been a prerequisite for customized microscope configurations. However, modularity has never before been implemented so consistently. This new versatile stand from Carl Zeiss is your microscope in every respect. With its unusual flexibility, it can be used universally – and yet, it can be individually tailored to your applications. More affordable than ever because you only buy what you need. Axio Scope can be easily upgraded to meet your growing demands. You will be equally impressed by the cost benefits and the performance. Axio Scope – the upright routine microscope for industrial applications.

Contents

Flexible and Affordable	6-7
Space Provides Full Freedom	8-9
Visible Differences	10-11
Impressive Variety	12-13
Tangible Operating Comfort	14-15
Digital High Performance	16-17
Unshakable Facts	18-19
Axio Scope: System Overviews	20-24
Solid Advantages	25



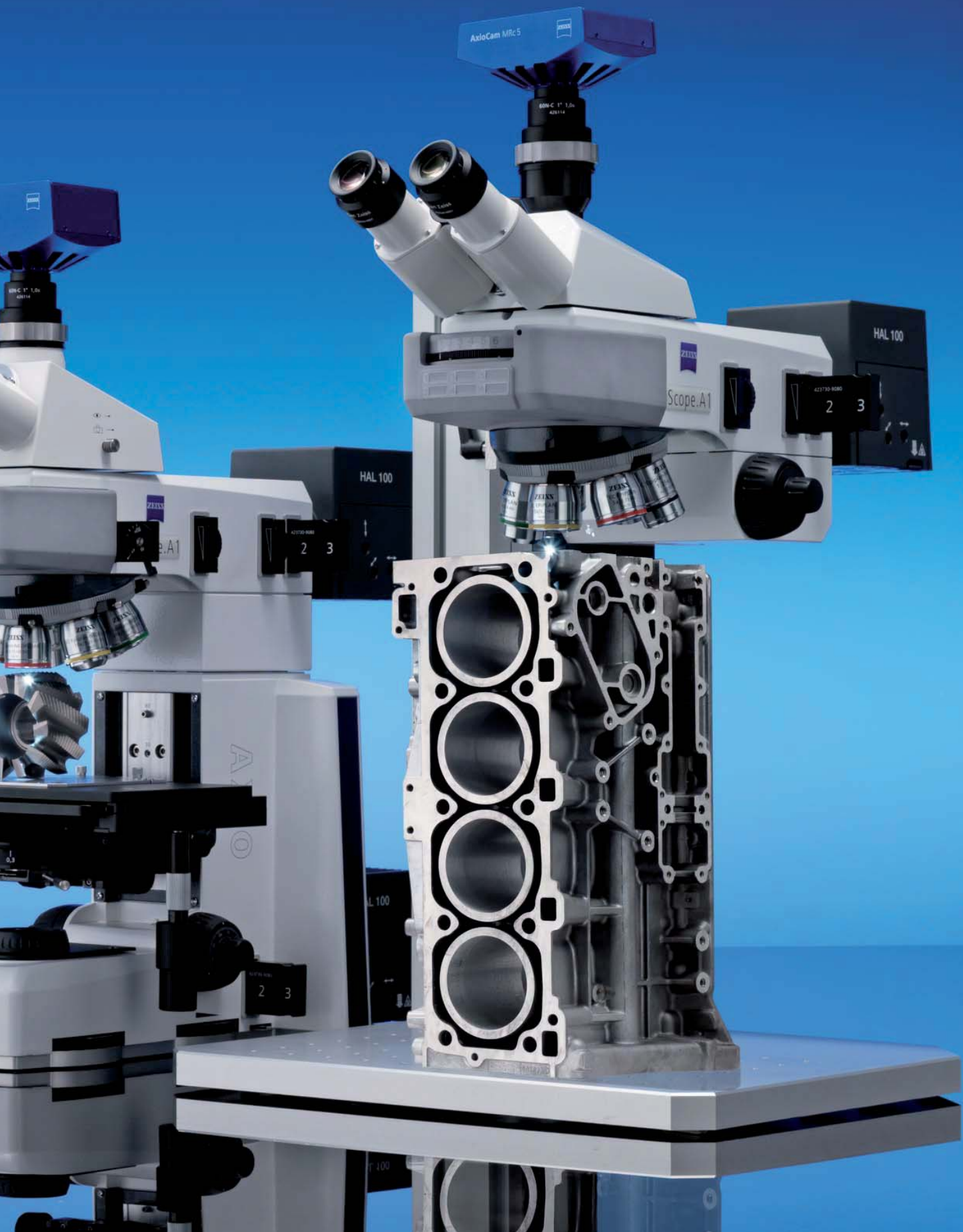

AutoCam MRc 5

60x C 1" 1.2x
428114

ZEISS
Scope.A1

HAL 100

42370-8080
2 3

HAL 100

42370-8080
2 3

HAL 100

42370-8080
2 3

HAL 100

Flexible and Affordable

Twenty-three Stand Versions. Innumerable Interfaces.

An Outstanding Solution for Your Application and Budget.

A vast number of stand versions and interfaces result in unusual flexibility. This means, configuring your Axio Scope in whatever way is useful for you. Functionally and economically.

New modularity

Axio Scope is as individual as the applications that you use it for. You can customize your stand from five upper parts, three lower parts and two Vario columns, from simple to more complex tasks. For transmitted-light, reflected-light or both techniques. What is important is that you no longer invest in functions that you don't use. A tangible advantage for your budget.

Affordable upgrading

Simpler and less costly – the modular interface concept of Axio Scope makes future upgrades quite simple. An attractive economical aspect as you can install many of the components yourself without a service engineer.

Versatile range of use

Axio Scope provides a range of uses which are as versatile as the tasks found in industry and research. They range from simple routine applications to more complex research projects. From quality control to material analysis and development. From surface examination and structure characterization to complex digital analysis.

The upper parts*

- I. For pure transmitted-light applications
Equipment: objective turret with 6x BF
- II. For standard fluorescence applications
Equipment: objective turret with 3x DIC/3x BF, standard light interface for HBO 50, HBO 100, HXP 120, Colibri etc.
- III. For LED fluorescence applications
Equipment: objective turret with 3x DIC/3x BF, integrated LED illumination that can take 4 different LED modules, synchronized switching with the reflector turret, long operating life, highly economical
- IV. For reflected-light (BF, DF) and fluorescence applications
Equipment: objective turret 6x BF/DF, standard light interface for HAL 100 or HBO, DF use in the objective turret, switchable diffuser
- V. For reflected-light (BF, DF, DIC) and fluorescence applications
Equipment: objective turret 6x BF/DF/DIC, standard light interface for HAL 100 or HBO, DF use in the objective turret, switchable diffuser, removable aperture and field diaphragm, carrier for polarizer slider

* Specimens of greater height can be examined, by inserting spacers between the upper parts (I-V) and the lower parts (A, B, C), so that the specimen space extends in z direction. This is now very easy thanks to the new customer interface. With the 30 mm spacer: extension of the maximum specimen height to 80 mm, with the 60 mm spacer: extension of the maximum specimen height to 110 mm.

BF = Brightfield, DF = Darkfield, BD = Brightfield/Darkfield, DIC = Differential Interference Contrast, C-DIC = Circular DIC, Pol = Polarization contrast, LD = Long Distance (big working distance)



The variety of interfaces is a performance feature of Axio Scope. It varies according to the upper and lower part used. In the example upper part V and lower part B.

1. Tube for optional
 - intermediate plate
 - tube lens turret or
2. Upper part
3. Reflector space
 - 2x slider
 - 4x turret
 - 6x turret
 - ISCP (only for transmitted-light)
4. Upper part for optional
 - 30 mm or 60 mm spacer or for
5. Lower part
6. Stage carrier
7. Stage
8. Condenser carrier
9. Transmitted-light filter wheel
10. Compartment for 6x20 mm slide, compensators, C-DIC slider
11. Compartment for DIC slide
12. Objectives
13. Compartment for rotating polarizer
14. Removable field diaphragm level
15. Removable aperture diaphragm level
16. Reflected-light filter slider
17. Achromatic illumination adapter and interface to HAL 100/HBO etc. illumination
18. Transmitted-light filter slider

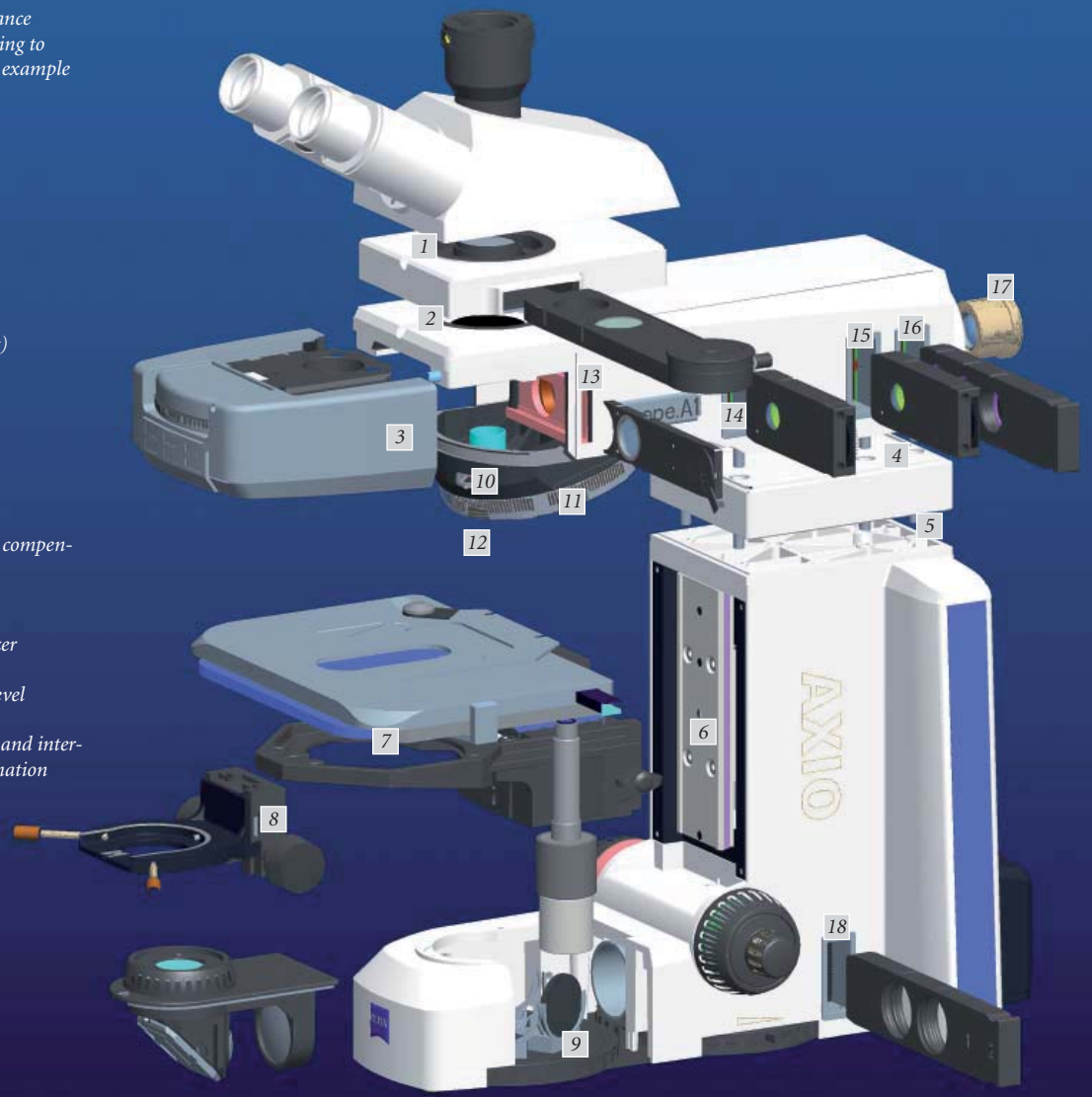

The lower parts*

- A. For pure reflected-light microscopy and LED transmitted-light applications, very simple lower part, contains no optical path: suitable for pure reflected-light microscopy or a LED illumination (Fixed-Koehler) can be attached directly below the condenser carrier for transmitted-light applications
- B. All standard transmitted-light applications
Illumination: 50 W reflector light, koehlerable beam path with field diaphragm and aperture diaphragm, filter slider and 6-position filter wheel

- C. For demanding transmitted-light applications with high-intensity illumination
Illumination: 100 W halogen, koehlerable beam path with field diaphragm and aperture diaphragm, filter slider and 6-position filter wheel

The stand columns

- For examination of large specimens for reflected-light and fluorescence applications
- D. Vario column 380 mm
- E. Vario column 560 mm



Space Provides Full Freedom

Space for Thin Sections. Space for Specimens up to 380 mm in Height. The Flexibility of the Specimen Space is Extraordinary.

This highly flexible material microscope offers space even for unusual specimens. For specimens that do not correspond to the standard. The size of the specimen space can be scaled according to your needs. And this clearly makes the overall handling easier for you.

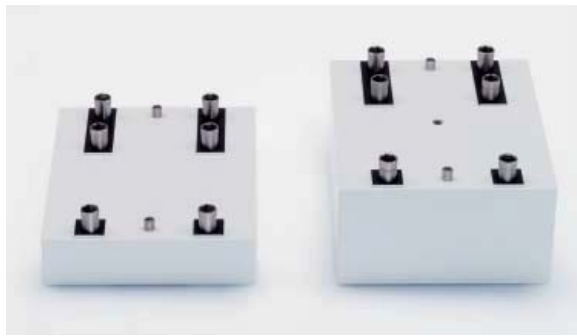

Flexible option for further extension of the specimen space in z direction: spacer in 30 mm and 60 mm versions.

From 0 to 110 mm: the scalability of the specimen space

With the flexibility of its specimen space Axio Scope points the way to freedom of action and an unusual range of uses. The material stand from Carl Zeiss offers you several options for extending the specimen space. In addition to the travel in z direction

- the stage carrier can be lowered on the dovetail,
- the condenser carrier can be removed, e.g. if the stage should be lowered beyond the travel range,
- and you can further extend the specimen space at the interface between upper and lower part by inserting a 30 mm or 60 mm spacer – continuously up to 110 mm.

The modular interface concept allows easy handling, e.g. when using the spacer (30 mm or 60 mm) to enlarge the specimen space.





Open for exceptional specimens: with the Vario stand columns the specimen space can be extended for heights up to 380 mm.

**For specimen heights up to 380 mm:
the stand columns**

The Axio Scope Vario 380 mm or Axio Scope Vario 560 mm are available to you as an alternative to the lower parts for your reflected-light and fluorescence applications. Thus you extend the specimen space for large objects up to 200 mm or 380 mm respectively. An important operating advantage is the crank device on the top of the stand columns. This crank allows to continuously adjust the vertical position of the microscope body without having to use a tool. The selection of the upper part is up to you.

Optimized at all heights: vibration stability

Consistently low in vibration, based on a heavy metal base plate, the special design of the stand columns also fulfils high demands on stability.

The specimen space is continuously adjustable for specimen thicknesses from 0 to 110 mm, simply by adjusting the height of the stage carrier.



Visible Differences

Ahead in Performance for Highest Demands. Efficient Solutions for Routine Work. The Optical System Design: Unique in This Class.

Outstanding in transmission, homogeneity and correction – the entire optical system of Axio Scope has been tailored to the requirements of material analysis. The improved image contrast and color fidelity as well as clear increases in quality and performance are now available in the routine class.

High contrast: the reflected-light beam path

Newly designed, the reflected-light beam path of Axio Scope sets the standards in its class. The homogeneous illumination over the full field of view provides consistently brilliant image quality. And with high quality in all contrasting techniques. In addition you also profit from the flexibility of the modular system. This applies for example to the retrofitable achromatic correction lens system that brings the optical quality of Axio Scope to the high IC²S level (Infinity Contrast & Color Corrected System).

Individually configurable: the transmitted-light beam path

The great flexibility in configuring the transmitted-light beam path of the Axio Scope is new and unique. At the front you have a 6-position filter wheel, which comes equipped with integrated shutter as well as with individual gray and color filter options. At the back you can also use a filter slide, which can be easily mounted, so that nearly any combination of filters is possible.

LED or halogen: the standard illuminations in transmitted-light

You can choose between three lower parts optimized for different light sources. 1. For transmitted-light LED: long life, free of adjustment and thus especially economic, this illumination offers sufficient intensity for typical routine tasks. 2. For 50 W reflector illumination: it offers more than sufficient light for all standard techniques such as brightfield or phase contrast. 3. For the 100 W halogen light, ideal for thick specimens and techniques with high light requirement such as DIC at high magnifications.

100 W halogen light: the light source for reflected-light

The 100 W halogen lamp ensures sufficiently bright illumination. The bulb can also be aligned in x, y and z for optimum illumination. Lamp exchange is easy – it can be done without tools, without detaching the lamp housing from the stand thanks to the lamp drawer.



Reflected-light C-DIC

From routine to the highest demands: the EC Epiplan objectives

Customized to your requirements, Axio Scope offers you a wide range of objectives of different price and performance classes. Carl Zeiss Enhanced Contrast objectives, in short: EC, are distinguished by minimized stray light and reflections, improved transmission and improved homogeneity. The effects of the reflected-light illumination concept make the most of these quality features in Axio Scope. With excellent quality images.

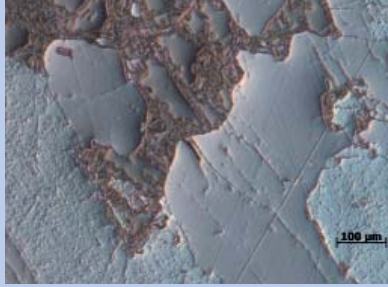

Reflected-light C-DIC

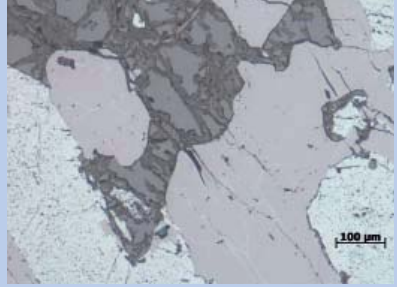

Reflected-light brightfield

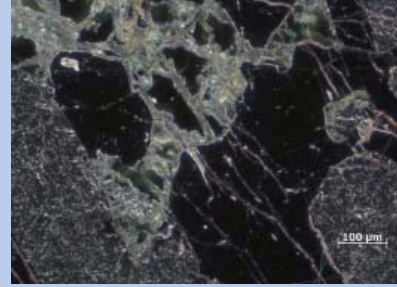

Reflected-light darkfield

The objective series for the powerful material microscopes are customized for different requirements and applications from economical and flexible up to highest resolution and correction.

• EC Epiplan objectives

Achromatically corrected and produced with low strain for performing DIC in convincing quality, the economic all-round objective series generates a flat field corrected image for an intermediate image size of 23 mm. Available as brightfield and brightfield/darkfield version. Because of the same position of the exit pupils, one can now achieve Differential Interference Contrast in circular polarized light with all EC Epiplan objectives with only one C-DIC prism.



• EC Epiplan-NEOFLUAR objectives

The especially high-contrast objectives are corrected to a high degree and produced with low strain for brilliant C-DIC. They generate a flat field corrected 25 mm field of view. Available as DIC, BD, C-DIC, Pol and LD versions. Perfect for displaying fine color and structural details such as lamellar and spheroidal graphite. But this optical talent offers even more. Large working distances and high numeric apertures.



• EC Epiplan-APOCHROMAT objectives

The EC Epiplan-APOCHROMAT objectives lead the field. Based on the ICS optics of Carl Zeiss, these innovative Enhanced Contrast objectives push the limits of what optics can achieve in regard to contrast and reproduction accuracy. This objective series stands for the best correction and the largest numeric aperture, e.g. the objective EC Epiplan-APOCHROMAT 20x/0.60. They are extremely well suited for imaging the finest color and structural details in the submicrometer range.



You will find further information under www.zeiss.de/objectives

Impressive Variety

The Darker Darkfield. The More Flexible Contrasting Techniques. The Thrilling Contrasting Possibilities of Axio Scope.

Tailored to the special requirements of material microscopy, a multitude of contrasting options has been implemented for Axio Scope. Suitable for every specimen, every application and unique in this class of microscope.



Exchangeable: the standard lens system and the achromatic correction lens system

Excellent in all techniques: the contrast

Brilliant, high-contrast images are the visible result of the newly computed reflected-light beam path of the Axio Scope. Achieved by well proven IC²S optics plus the consistent minimization of disturbing stray light. Decisive for achieving outstanding contrast. A retrofittable achromatic correction lens system is bringing the optical quality of Axio Scope to high IC²S level (Infinity Contrast & Color Corrected System) is available to you for higher demands. Unique in this class.

Interface for your reflector inserts: the infinity space

Unique in this class: the interface in the infinity space. Axio Scope offers you the possibility of using reflector inserts that are most suitable for your applications. You can choose from a 2x slider for simple brightfield and darkfield applications as well reflector turrets with four or six positions. The 6x turret offers sufficient free positions to accommodate, for example BF, DF, Pol and C-DIC in reflected-light as well as BF and Pol in transmitted-light. Irrespective whether slider or turret solution: the change between the contrasting techniques is a simple matter. On one hand sliders and turrets can be fitted and changed easily with Push&Click modules, on the other hand their optical modules are kept safely and free of dust. Axio Scope offers an additional special feature. The interface for reflector inserts can be used as camera port for transmitted-light applications (ISCP: Infinity Space Camera Port).



The interface in the infinity space enables a variety of applications: the 4x and 6x reflector turret, the Infinity Space Camera Port (ISCP) as well as the 2x reflector slider.

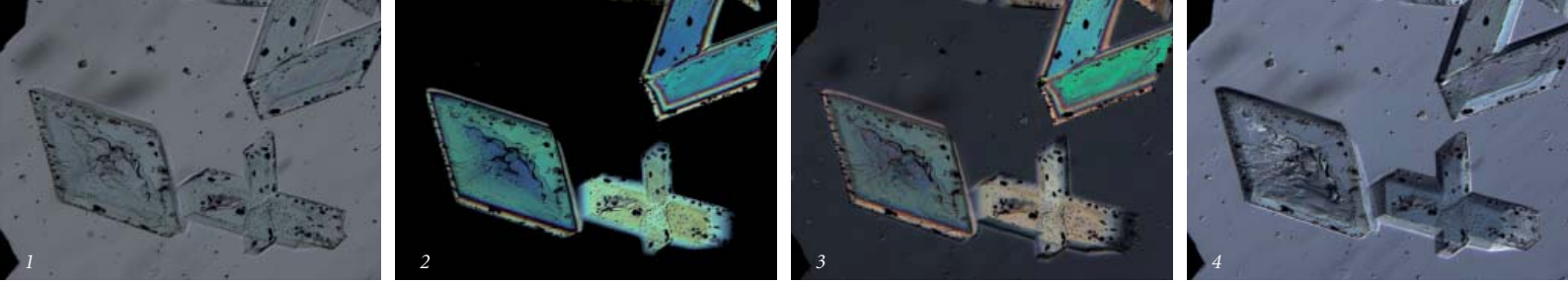

Copper sulfate crystals in transmitted-light: 1. Brightfield, 2. Polarization, 3. conventional DIC and 4. PlasDIC. With PlasDIC there is, for the first time, the possibility for the brilliant illustration of the morphology.

Versatile options: the contrasting techniques

The variety of reflected- and transmitted-light techniques that Axio Scope offers you is unusual in this performance class. Perfectly tailored to your tasks in routine and research. The most important contrasting techniques include:

In reflected-light:

- Brightfield
- Darkfield
- Polarization
- DIC
- C-DIC
- Fluorescence

In transmitted-light:

- Brightfield
- Polarization
- Darkfield
- DIC
- PlasDIC
- Phase contrast

Darker: the darkfield

The high quality of the newly designed reflected-light beam path is shown in the clear enhancement of darkfield contrast. Thanks to minimizing disturbing stray light, this darkfield can cope with even the most demanding specimens. Captivating with a homogeneously black background. Delighting you by making even the finest structures visible.

Perfect for oriented structures: C-DIC

Circular DIC, in short: C-DIC, is a polarization technique that in contrast to the customary Differential Interference Contrast (DIC) works with circularly polarized light. The advantages of the patented technique for contrasting differently oriented object structures are decisive. For instead of having to rotate the specimen, simple rotation of the knurled ring of the DIC slider is sufficient with C-DIC to visualize all object information one after the other. Continuously and related to the object. In this case every required shearing orientation can be set for every oriented structure. This

means that both high contrast and high resolution can be achieved with a DIC prism. For the entire series of the new all-round EC Epiplan objectives you require only one C-DIC prism for interference contrast in circularly polarized light (C-DIC).

Color-neutral variety: the polarizers

Axio Scope offers you a choice of polarizers of different performance classes, tailored exactly to your needs. The high degree of polarization is common to all polarizers from Carl Zeiss – color-neutral in the visible spectral range and thus perfect for brilliant images and precise measurements conforming to the standards.

Affordable yet powerful: PlasDIC

For the first time an alternative to the DIC is available generating a Differential Interference Contrast in transmitted-light in good quality even when the object, the object carrier, the condenser or the objective have an anisotropic character. PlasDIC is the technique of choice for examining anisotropic (birefringent) specimens, if you want to gain a relief impression. With visible advantages in regard to gaining information and brilliance. Specific features such as the morphology or the crystal growth of anisotropic phases can be detected clearly better with PlasDIC than with conventional brightfield, polarization or DIC techniques.

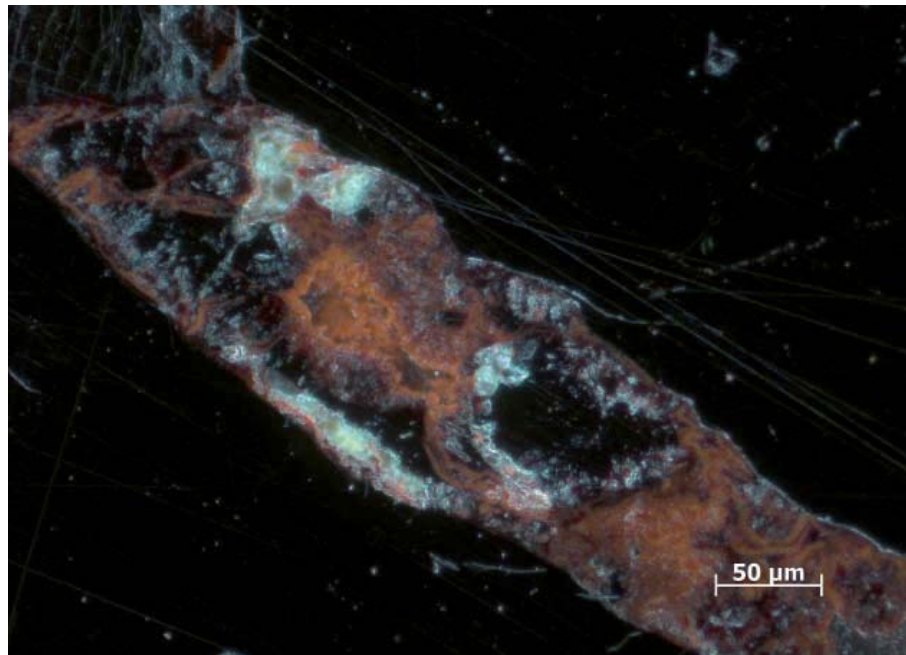

Tangible Operating Comfort

Convenient to Handle. Efficient in the Workflow. Operating Comfort and Ergonomics Fullfill Almost all Your Needs.

Developed for 24 hour use. Axio Scope will convince you in quality and stability. The many intelligent details that make your routine work a great deal easier and more pleasant to deal with.



Well conceived regulated: the intensity adjustment in Axio Scope is arranged on both sides around the focusing drive.

Well conceived operating controls

Simply intelligent – the design of Axio Scope has been well conceived in every point, to make operation of the stand as comfortable and safe for you as possible in your routine work. The intensity adjustment is arranged ergonomically around the focusing drive. Positioned on both sides near the focusing drive, it can be operated extremely conveniently. For you now control illumination settings without having to take your hands off the focus drive. According to your preference with your left or right hand.

Convenient stages

On Axio Scope the stage carriers are designed as a customer interface – with a wide range of different stage versions. These include different mechanical stages with large travel range in standard or ergonomic version. The new ergo stage is unique for Axio Scope: it offers the possibility to position the stage drive more than 90 mm along the y axis into the position that is most comfortable for you. It can be fixed in position and operated very conveniently without any need for you to change the position of your hand. A further advantage of Axio Scope: the stage carriers for reflected- and transmitted-light applications can be lowered or removed without tools using a dovetail. For instance for additional extension of the specimen space for larger specimens.



Unique for Axio Scope: the new ergo stage offers the possibility of bringing the stage drive into the position that is most pleasant for you.

Ergonomic tubes

Designed for long work days, Axio Scope places a special emphasis on ergonomics. The viewing angles of the ergotubes are based on modern studies and are designed for a fatigue-free, healthy posture. Two different versions are available to you.

- The height-adjustable ergotube with a travel range of 50 mm.
- The 50-15-50 comfort ergo phototube with upright side correct image, which can be set up to suit your height in the most comfortable way possible, with a fixed viewing angle of 15° and ability to individually adjust in height and depth by up to 50 mm.

Unshakable quality

Especially in routine applications, when working around the clock, the material and workmanship of the microscope are vitally important. Axio Scope is with heart and soul a microscope from Carl Zeiss. Unshakable with its sturdy stand construction and simply superior in its mechanical quality.

Axio Scope is designed for fatigue-free working, e. g. the height-adjustable ergo phototube.



Ergonomically sophisticated, the comfort ergo phototube with upright side correct image with a fixed viewing angle of 15° and individual height and depth adjustment of 50 mm.



Digital High Performance

Ready for the Leading Software. Ready for a Variety of Cameras. The Simple Step From Stand-alone Microscope to Documentation System.

Your Axio Scope Imaging System is more than the sum of microscope, software and camera: a complete solution from a single source. Fully integrated in the Carl Zeiss systems approach. With the security of one hundred percent compatibility – for now and the future.

Simply convenient: the AxioVision microscope software

Easy to operate and functional – with AxioVision you extend your Axio Scope to include digital documentation. The modular microscope software from Carl Zeiss offers you all the important functions in the basic version, from acquisition and processing up to analyzing and archiving your images.

AxioVision is one of the leading systems on the market. Primarily because this software is easy to operate. It is easy to adapt the user in interfaces and functions. Ideal for simplifying your routine applications through clear workflows and thus making them more efficient.

Fully integrated in the Carl Zeiss systems approach, Axio Scope can be extended to a powerful imaging platform.



From AutoMeasure up to TIC: the AxioVision modules

AxioVision offers you a large number of modules for flexible use especially for digital material microscopy. The TIC module is available in addition to the standard analysis modules such as Interactive Measurement, AutoMeasure and AutoMeasure plus with its functionalities for segmentation, binary image processing and automatic measurement. The TIC technique – Total Interference Contrast – enables accurate no-contact and thus very easy optical height and thickness measurement of object structures in the range of a few nanometers up to a few micrometers. The advantage of TIC compared with conventional layer thickness measuring instruments (profilometers, scanning force microscopy) lies in the short measuring and evaluation time with simultaneously high measuring accuracy.

Great in all performance classes: the cameras

From the AxioCam ICc1 or AxioCam ICc3, the smallest and most inexpensive digital color cameras, to the AxioCam HRc, the high-resolution camera: Axio Scope offers a connection for every type of camera. And Carl Zeiss provides the complete range of modern microscope cameras. Each of them carries the Carl Zeiss seal of quality. Axio Scope is also compatible with digital consumer cameras, e.g. from Canon. You receive the AxioVision LE software version free of charge. A good solution that already opens up many options for you in digital image acquisition.







*Pyroxene-rich chondrule fragment in Dar al Gani 327, Transmitted-light, polarization, enlarged 50x.
Dr. Jutta Zipfel, Meteorite Search Section, Senckenberg Research Institute and Natural History Museum, Frankfurt am Main, Germany*

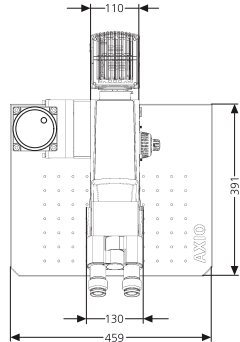
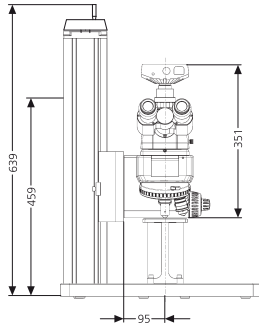
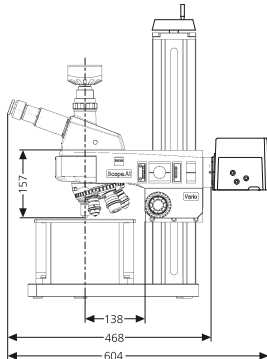
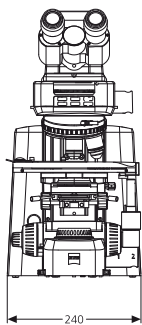
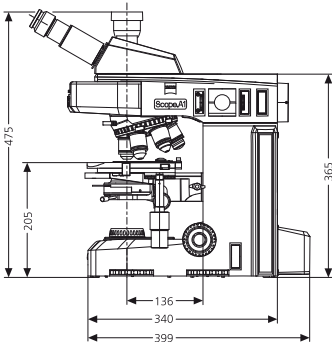

Ideal for routine application in materials microscopy: the inexpensive digital color cameras AxioCam ICc1 and AxioCam ICc3.

Unshakable Facts

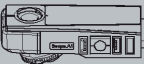
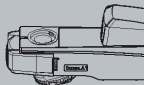

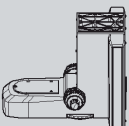
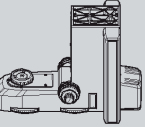
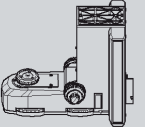
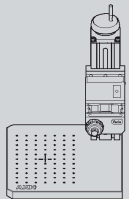
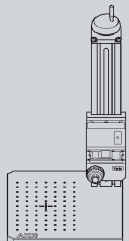
<p>Stand upper parts</p>  <p>Stand lower parts</p>	<p>Stand upper part Transmitted-light</p> <p>with objective turret 6x brightfield, M27</p> 	<p>Stand upper part FL/HBO</p> <p>with objective turret 3x brightfield, 3x DIC, M27</p> 	<p>Stand upper part FL-LED</p> <p>with objective turret 3x brightfield, 3x DIC, M27</p> 	<p>Stand upper part HAL 100/HBO</p> <p>with objective turret 6x brightfield/darkfield, M 27</p> 	<p>Stand upper part HAL 100/HBO</p> <p>with objective turret 6x brightfield/darkfield, DIC, M27</p> 
<p>Stand lower part for LED illumination</p> 	<p>Microscope stand Axio Scope.A1 LED, 6x BF</p> <p>430035-9200-000</p>	<p>Microscope stand Axio Scope.A1 LED, FL/HBO, 3x BF, 3x DIC</p> <p>430035-9210-000</p>	<p>Microscope stand Axio Scope.A1 LED, FL-LED, 3x BF, 3x DIC</p> <p>430035-9220-000</p>	<p>Microscope stand Axio Scope.A1 LED, HAL 100/HBO, 6x BD</p> <p>430035-9080-000</p>	<p>Microscope stand Axio Scope.A1 LED, HAL 100/HBO, 6x BD DIC</p> <p>430035-9090-000</p>
<p>Stand lower part for HAL 50 illumination</p> 	<p>Microscope stand Axio Scope.A1 HAL 50, 6x BF</p> <p>430035-9030-000</p>	<p>Microscope stand Axio Scope.A1 HAL 50, FL/ HBO, 3x BF, 3x DIC</p> <p>430035-9040-000</p>	<p>Microscope stand Axio Scope.A1 HAL 50, FL-LED, 3x BF, 3x DIC</p> <p>430035-9050-000</p>	<p>Microscope stand Axio Scope.A1 HAL 50, HAL 100/HBO, 6x BD</p> <p>430035-9100-000</p>	<p>Microscope stand Axio Scope.A1 HAL 50, HAL 100/HBO, 6x BD DIC</p> <p>430035-9110-000</p>
<p>Stand lower part for HAL 100 illumination</p> 	<p>Microscope stand Axio Scope.A1 HAL 100, 6x BF</p> <p>430035-9130-000</p>	<p>Microscope stand Axio Scope.A1 HAL 100, FL/HBO, 3x BF, 3x DIC</p> <p>430035-9060-000</p>	<p>Microscope stand Axio Scope.A1 HAL 100, FL-LED, 3x BF, 3x DIC</p> <p>430035-9070-000</p>	<p>Microscope stand Axio Scope.A1 HAL 100, HAL 100/HBO, 6x BD</p> <p>430035-9140-000</p>	<p>Microscope stand Axio Scope.A1 HAL 100, HAL 100/HBO, 6x BD DIC</p> <p>430035-9120-000</p>
<p>Stand column Axio Scope Vario 380 m</p> 		<p>Axio Scope stand upper part FL/HBO, 3x BF, 3x DIC, M27</p> <p>423730-9030-000</p> <p>Axio Scope Vario stand column 380 mm</p> <p>451017-9010-00</p> <p>Axio Scope Vario drive box, focus lift 15 mm</p> <p>430036-9000-000</p>	<p>Axio Scope stand upper part FL-LED, 3x BF, 3x DIC, M27</p> <p>423730-9050-000</p> <p>Axio Scope Vario stand column 380 mm</p> <p>451017-9010-00</p> <p>Axio Scope Vario drive box, focus lift 15 mm</p> <p>430036-9000-000</p>	<p>Axio Scope stand upper part HAL 100/HBO, 6x BD, M27</p> <p>423730-9060-000</p> <p>Axio Scope Vario stand column 380 mm</p> <p>451017-9010-000</p> <p>Axio Scope Vario drive box, focus lift 15 mm</p> <p>430036-9000-000</p>	<p>Axio Scope stand upper part HAL 100/HBO, 6x BD DIC, M27</p> <p>423730-9070-000</p> <p>Axio Scope Vario stand column 380 mm</p> <p>451017-9010-000</p> <p>Axio Scope Vario drive box, focus lift 15 mm</p> <p>430036-9000-000</p>
<p>Stand column Axio Scope Vario 560 mm</p> 		<p>Axio Scope stand upper part FL/HBO, 3x BF, 3x DIC, M27</p> <p>423730-9030-000</p> <p>Axio Scope Vario stand column 560 mm</p> <p>451017-9000-000</p> <p>Axio Scope Vario drive box, focus lift 15 mm</p> <p>430036-9000-000</p>	<p>Axio Scope stand upper part FL-LED, 3x BF, 3x DIC, M27</p> <p>423730-9050-000</p> <p>Axio Scope Vario stand column 560 mm</p> <p>451017-9000-000</p> <p>Axio Scope Vario drive box, focus lift 15 mm</p> <p>430036-9000-000</p>	<p>Axio Scope stand upper part HAL 100/HBO, 6x HD, M27</p> <p>423730-9060-000</p> <p>Axio Scope Vario stand column 560 mm</p> <p>451017-9000-000</p> <p>Axio Scope Vario drive box, focus lift 15 mm</p> <p>430036-9000-000</p>	<p>Axio Scope stand upper part HAL 100/HBO, 6x BD DIC, M27</p> <p>423730-9070-000</p> <p>Axio Scope Vario stand column 560 mm</p> <p>451017-9000-000</p> <p>Axio Scope Vario drive box, focus lift 15 mm</p> <p>430036-9000-000</p>

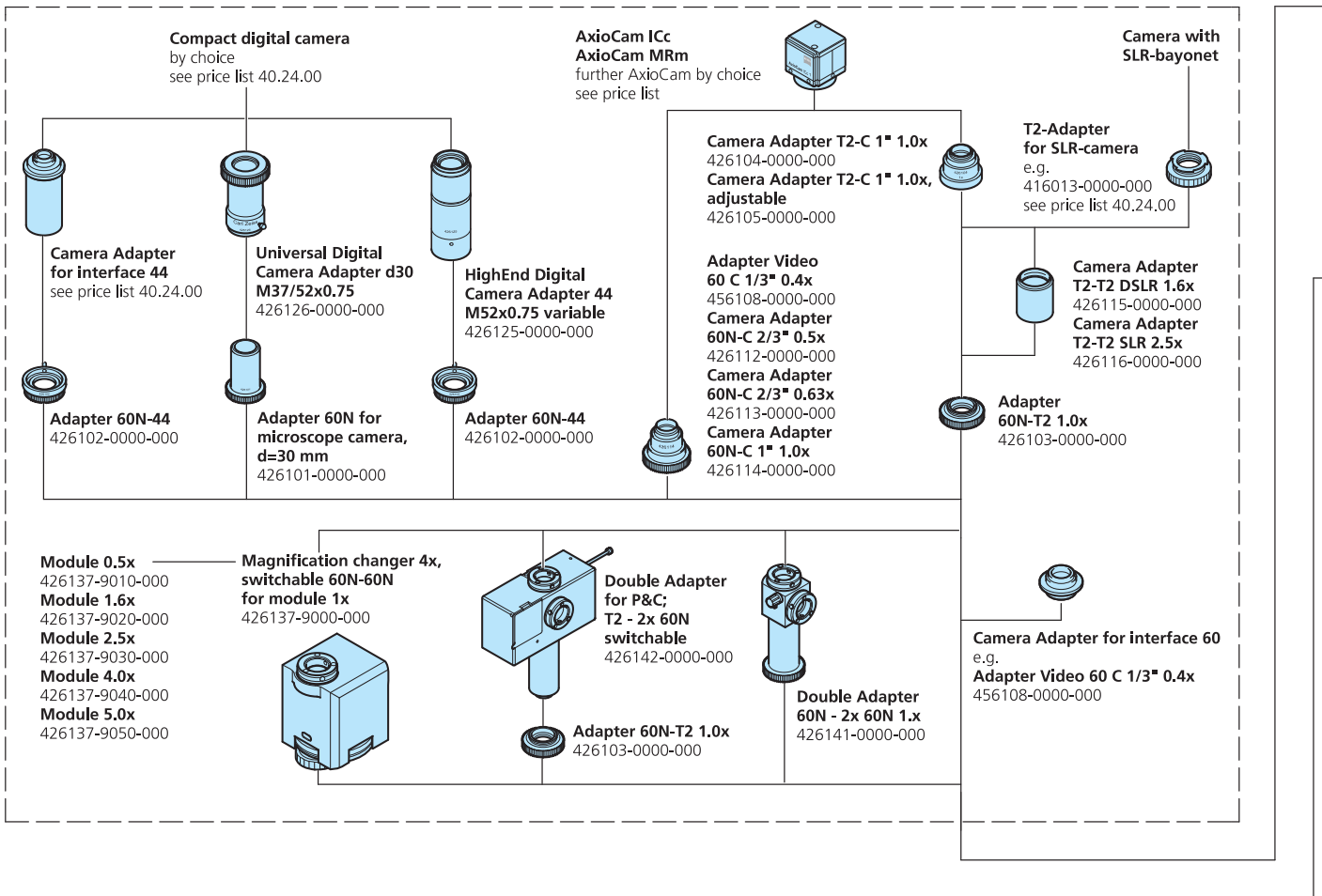

3-position tube-lens turret with tube-lens 1x
425313-9010-000
(only usable with the tubes:
425500-0000-000
425501-0000-000
425503-9901-000
425515-0000-000
in combination with SF 23 eyepieces)

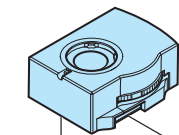

Tube-lens 1.25x
425303-0000-000

Tube-lens 1.6x
425304-0000-000

Tube-lens 2.5x
425305-0000-000

Tube-lens 4.0x
425307-0000-000

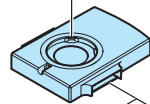

Intermediate plate for analyzer slider 12x46
425313-9020-000
(not usable with Ergotubes and Ergophototubes with vertical adjustment)

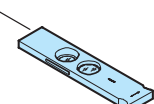

Analyzer slider D/A, fixed
428101-0000-000

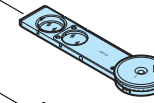

Analyzer slider D/A with lambda-plate rotatable 360°
428102-0000-000

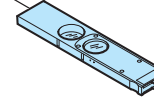

Analyzer slider D/A, 360° rotatable
428103-0000-000



Analyzer slider D/A with lambda-plate, each rotatable +/- 10°
453663-9901-000

Low-power system for objectives 2.5x/4x for condenser 0.9/1.25 H
424225-9050-000



LED illuminator for transmitted light
423904-9902-000

Slider with polarizer for LED illumination
427708-0000-000

Color filter carrier 3x for filter d=32 mm
428305-0000-000

Swing-in polarizer
453617-0000-000

Polarizer D, fixed, removable
427701-0000-000

Polarizer rotatable with color filter carrier
427707-0000-000

Polarizer D, 90° rotatable, removable
427706-0000-000

Polarizer fixed with lambda plate rotatable
445226-0000-000

Circular polarizer D, fixed with lambda/4 plate, rotatable
453623-0000-000
containing:
Slider 6x20 with lambda/4 plate

Circular polarization unit D ACR, with lambda/4 plate, rotatable
447703-9901-000
containing:
Reflector module lambda/4 plate, ACR

1

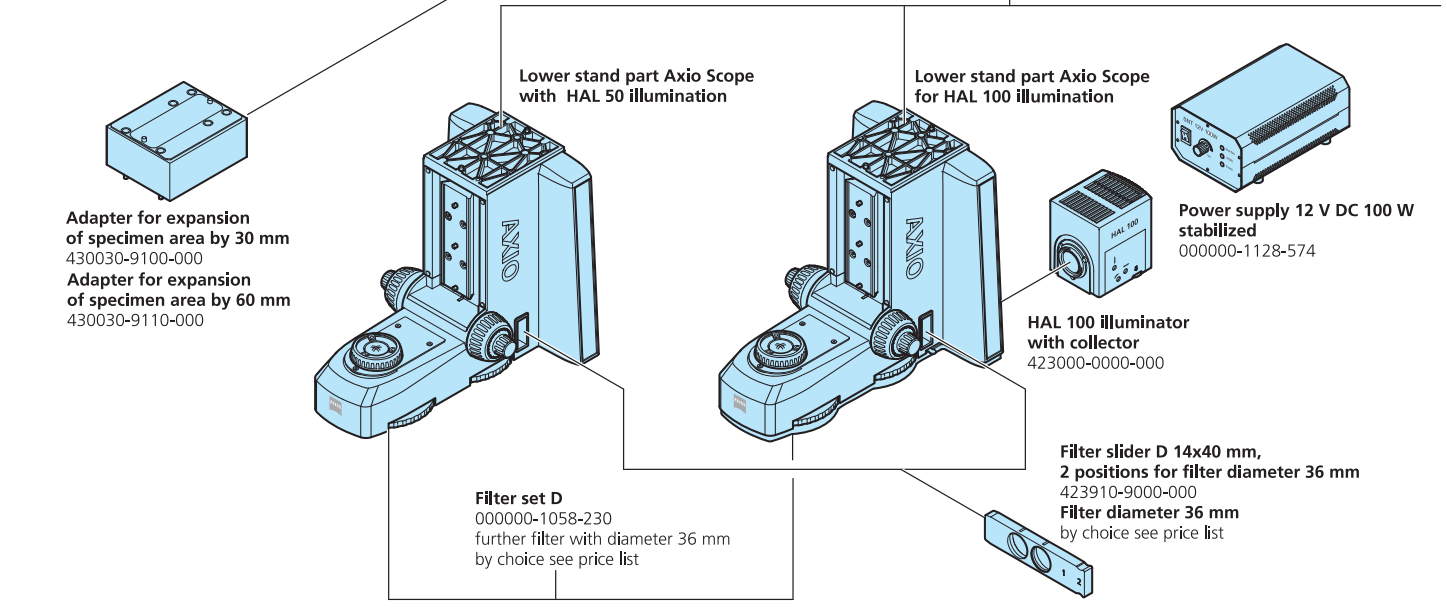
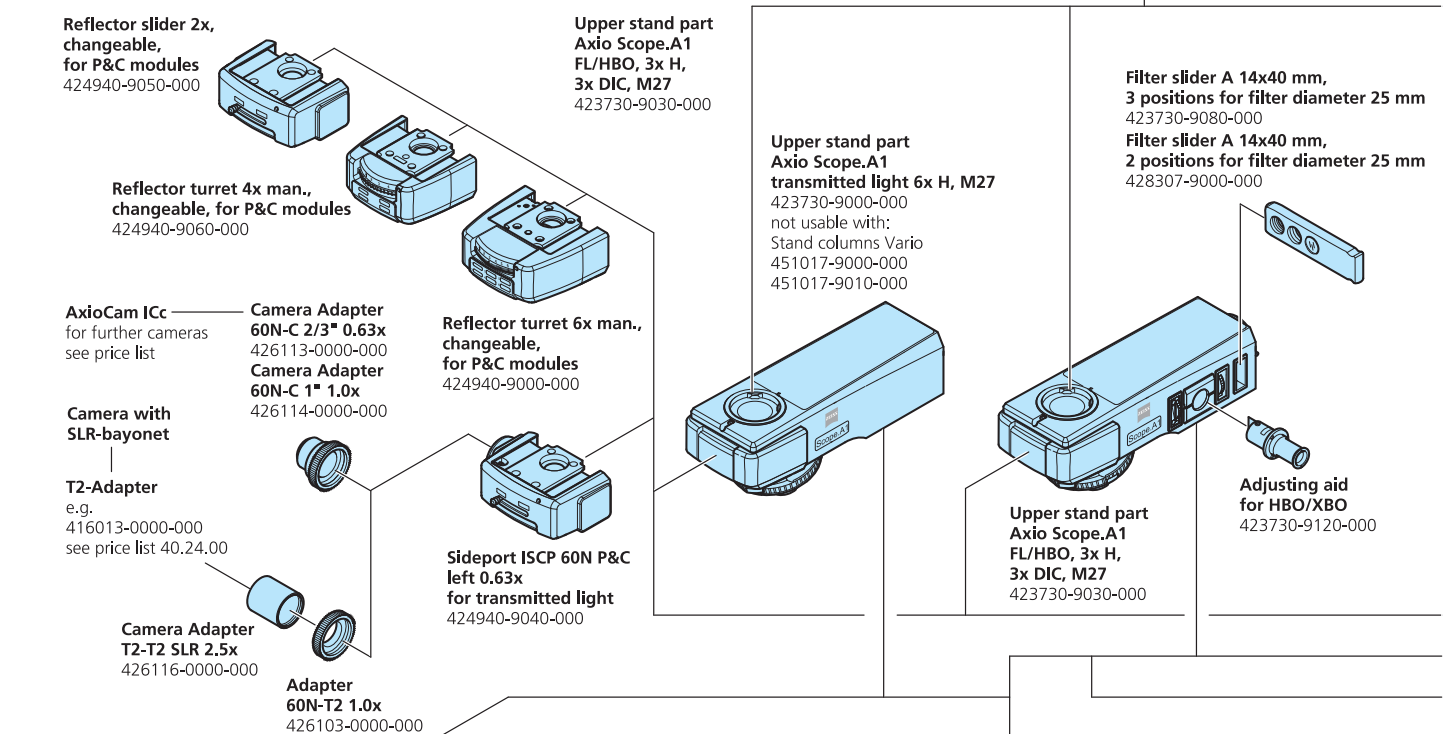
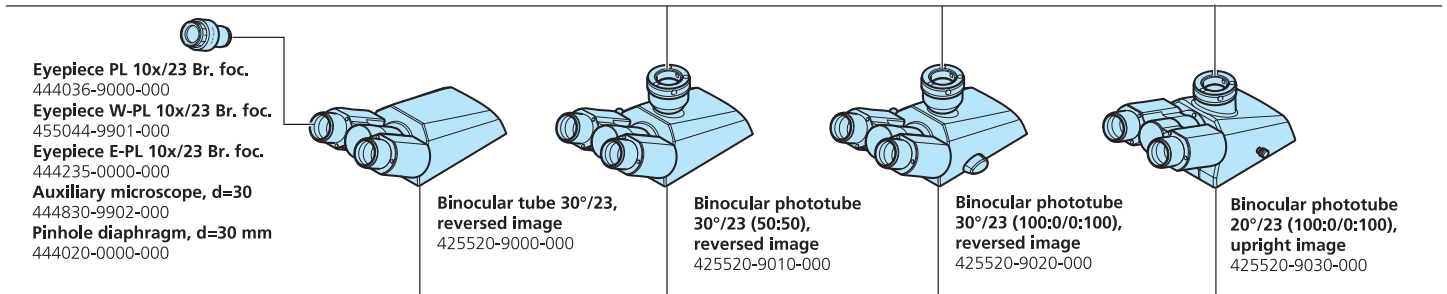

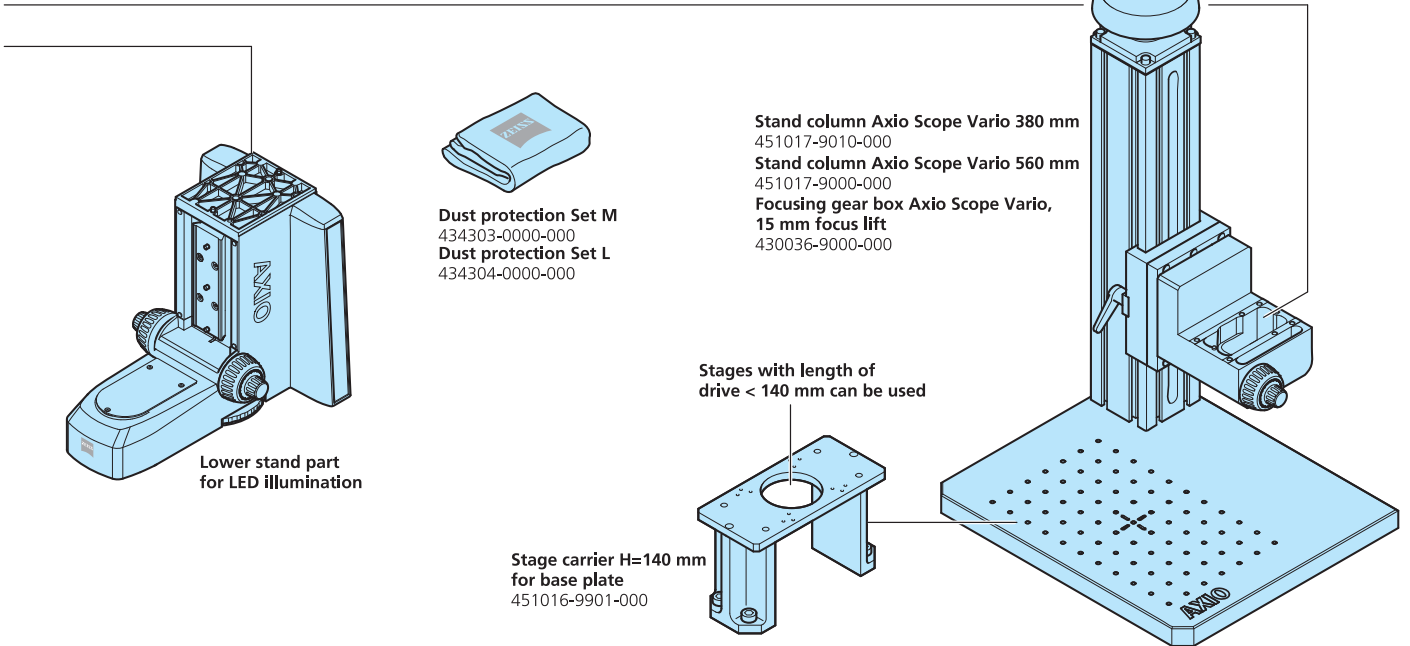
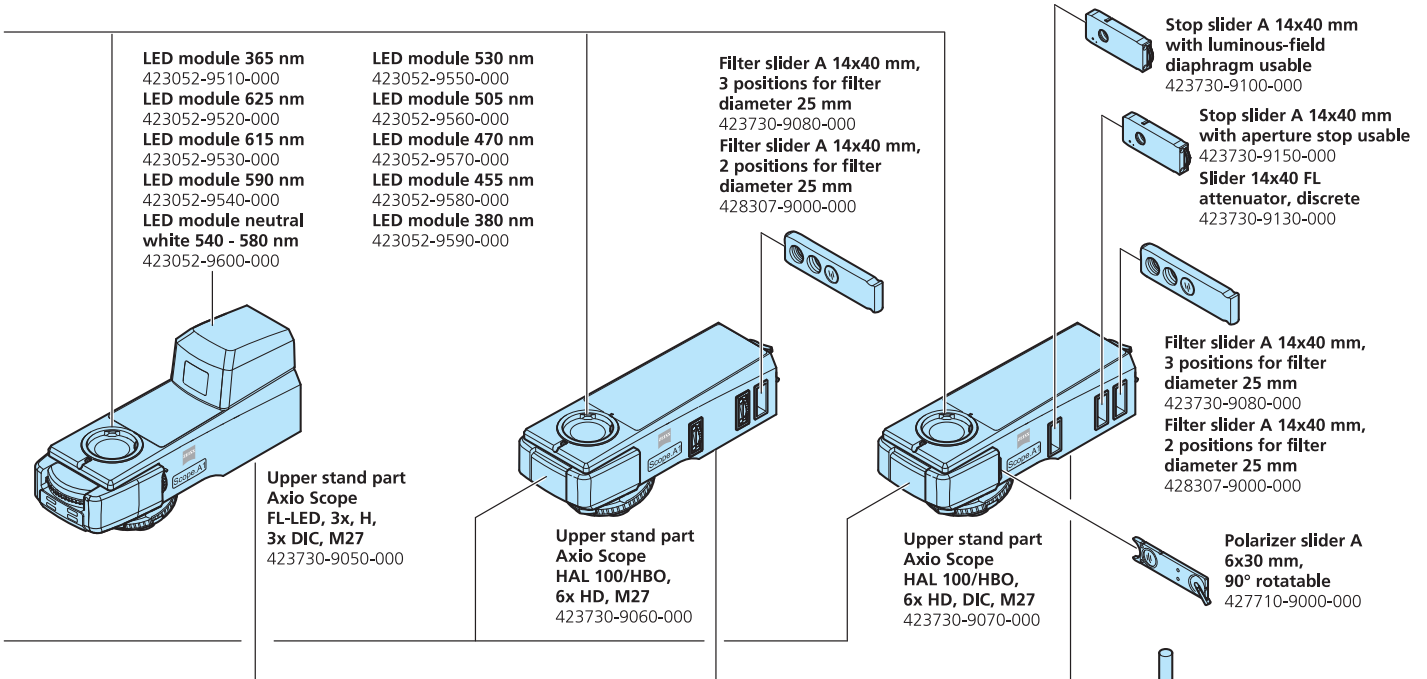
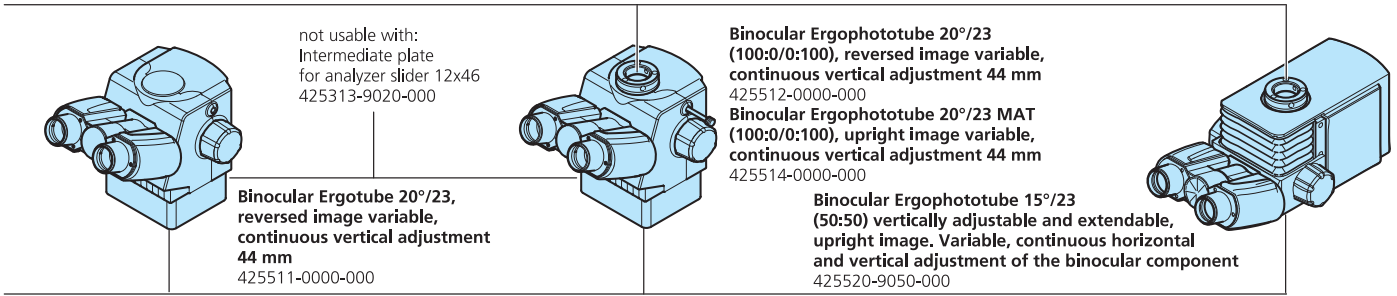

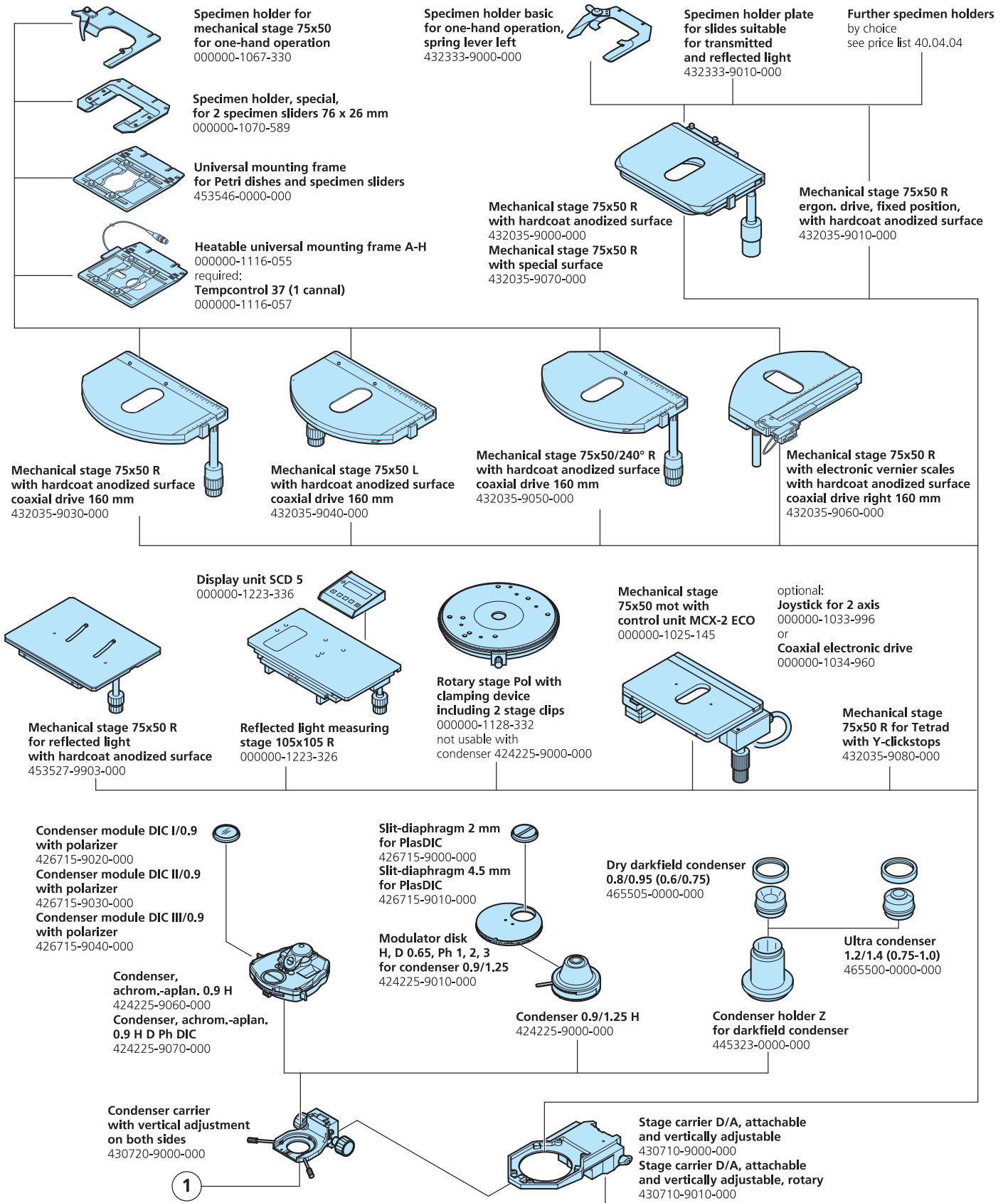

System Overview

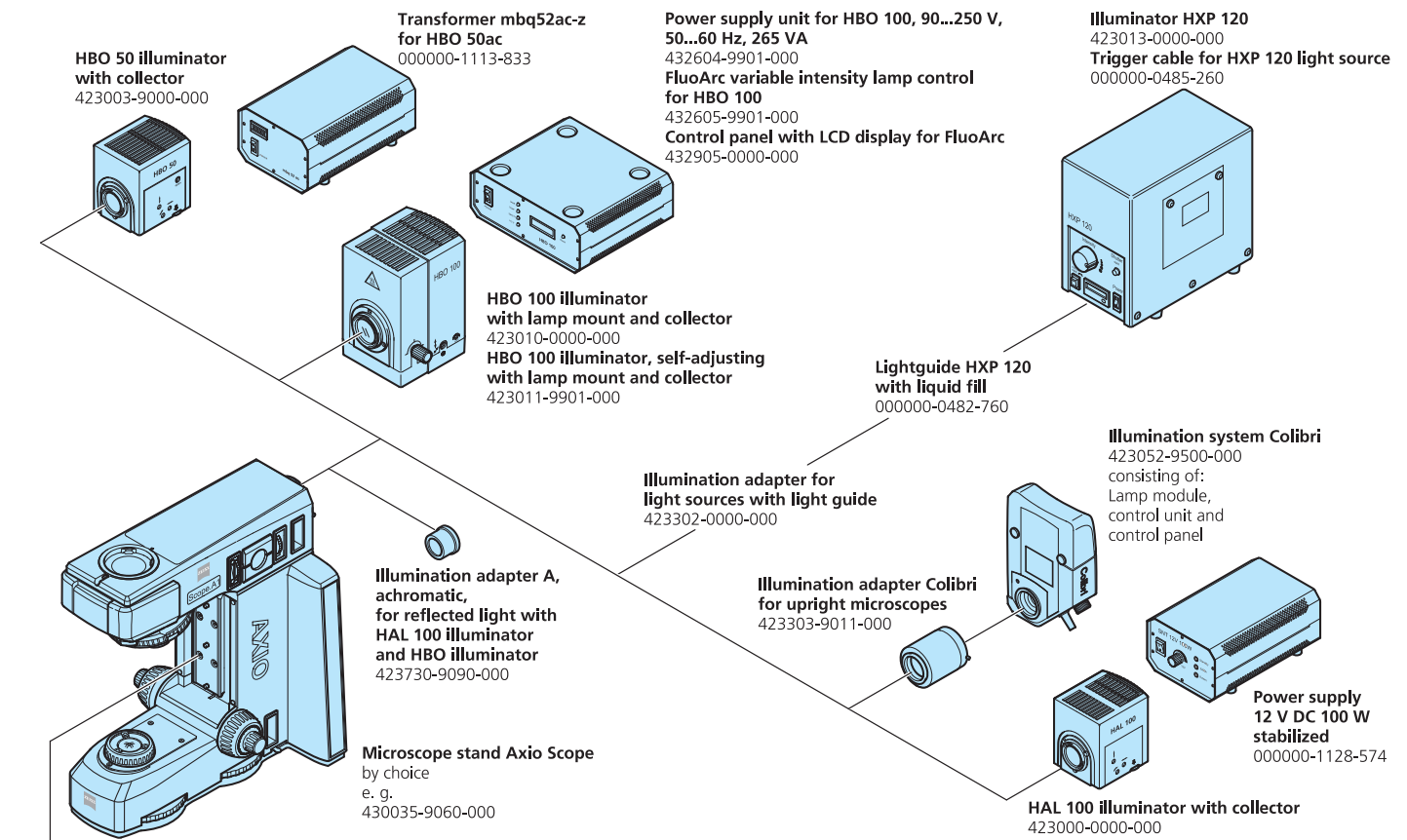
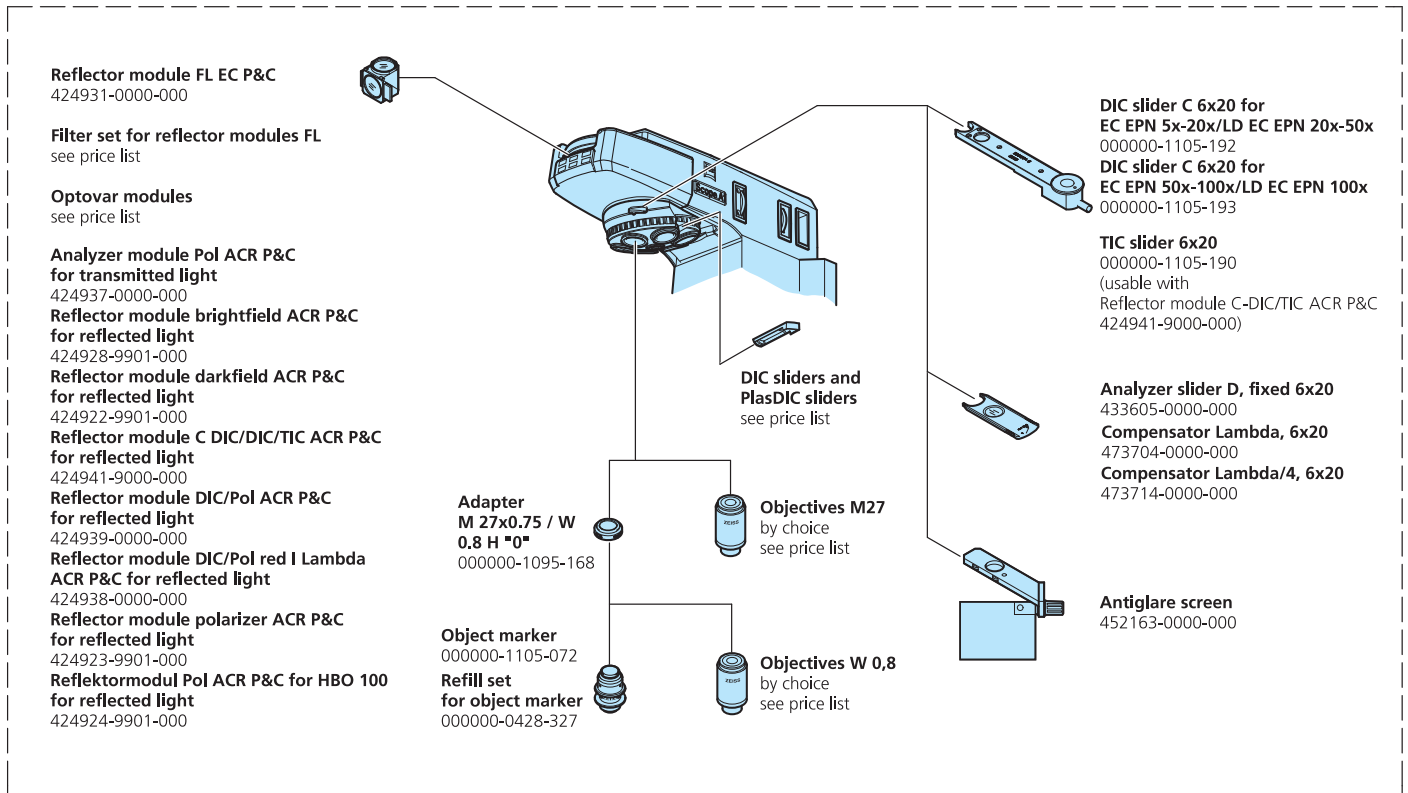

Solid Advantages

23 stand combinations – a perfect solution

You configure your Axio Scope from five upper parts, three lower parts or two Vario columns. Made to measure for simple routine applications, for demanding research tasks, for every budget.

Numerous interfaces

A large number of interfaces allows an exact adaptation to requirements and budget.

Economical upgrading

Many components can be added on by the customer as needed – easily and without additional service costs.

PlasDIC and C-DIC

In consistent response to many customer requests, the Differential Interference Contrast in circular polarized light (C-DIC) and the new PlasDIC relief contrast can now also be integrated in a routine microscope.

Variety of reflector inserts

Thanks to its customer interface in the infinity space, Axio Scope allows users to select the reflector insert most suitable for their relevant application. There is a choice of 2x slide, a 4x reflector turret and a 6x reflector turret.

EC Epiplan objectives – great for routine work and even high demands

A new series of these high-performance objectives is now available with Axio Scope. Made to measure for routine work, inexpensive and for versatile use.

Flexibility of the specimen space

Designed for very varied applications, Axio Scope offers unusually large variability of the specimen space. According to configuration continuously adjustable for specimen thicknesses from 0 to 360 mm.

Convenient intensity adjustment

The intensity setting of the illumination is arranged on both sides close to the focusing drive and is extremely convenient to operate with the left or right hand.

Conversion without tools

The stage carrier can be lowered easily without tools, e.g. for extending the specimen space.

Contemporary Imaging System

Suitable for cameras of different performance classes as for the basic and advanced versions and extended functionality of the AxioVision microscope software, Axio Scope grows to become a powerful documentation platform.

*Compound barred olivine chondrule in Dar al Gani 327, enlarged 20x, 1. Transmitted-light Brightfield, 2. Transmitted-light polarization.
Dr. Jutta Zipfel, Meteorite Search Section, Senckenberg Research Institute and Natural History Museum, Frankfurt am Main, Germany*

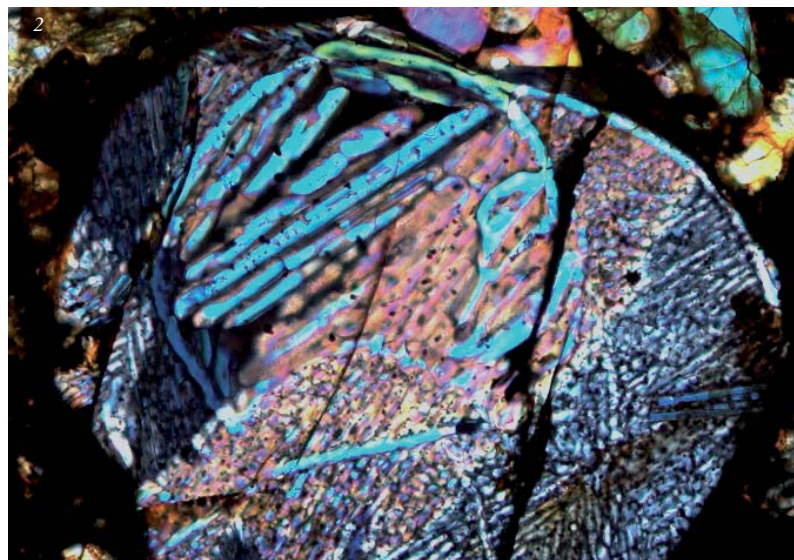

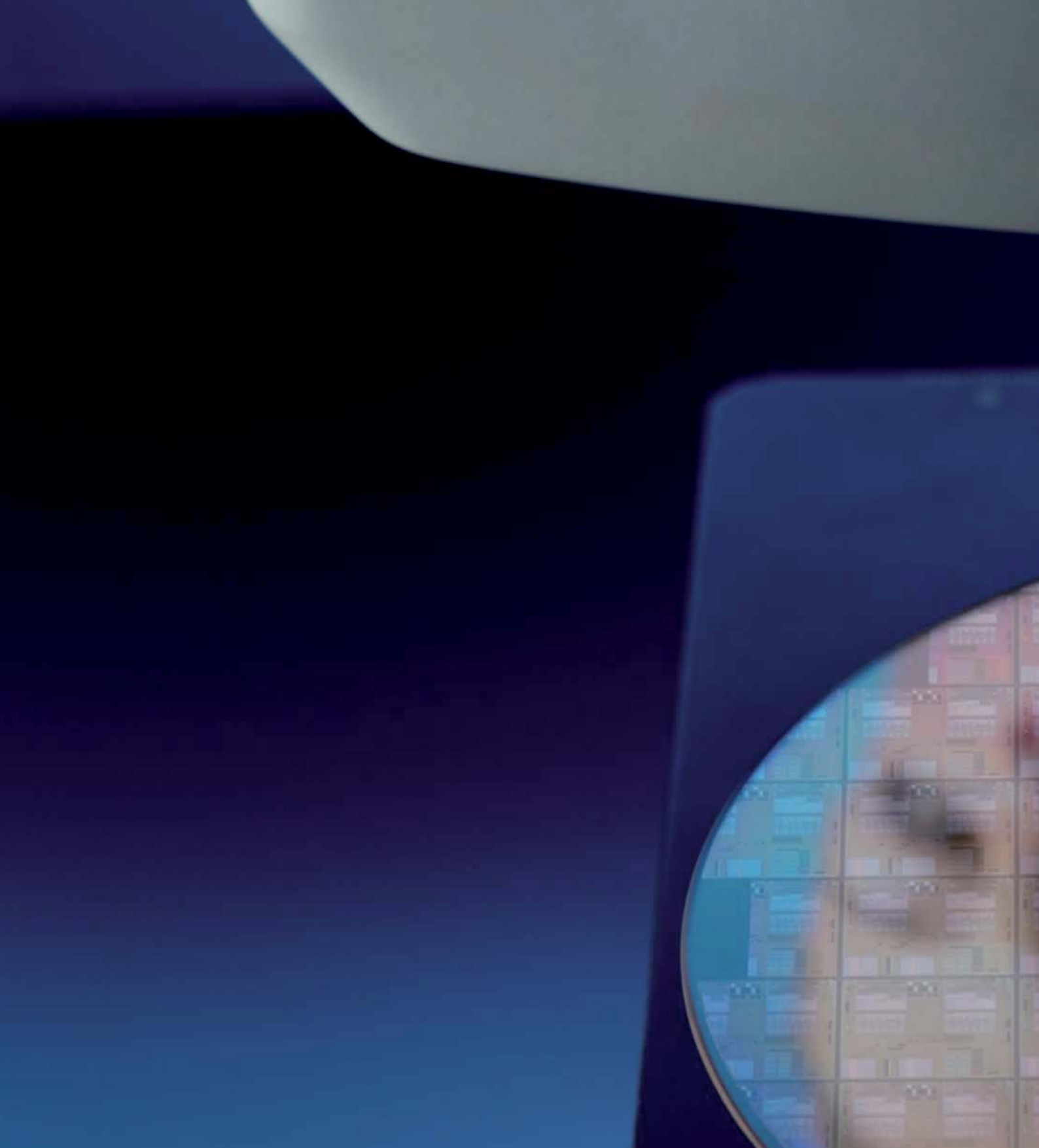

ryf ag  Ryf AG
Bettlachstrasse 2
2540 Grenchen
tel 032 654 21 00
fax 032 654 21 09
www.ryfag.ch