



Biological Microscope ECLIPSE E200



Biological Microscope
ECLIPSE
E200



Features exceptionally bright and uniform LED illumination and Nikon's high-quality optics. Ergonomic and anti-mold design ensures years of comfortable and stable use.

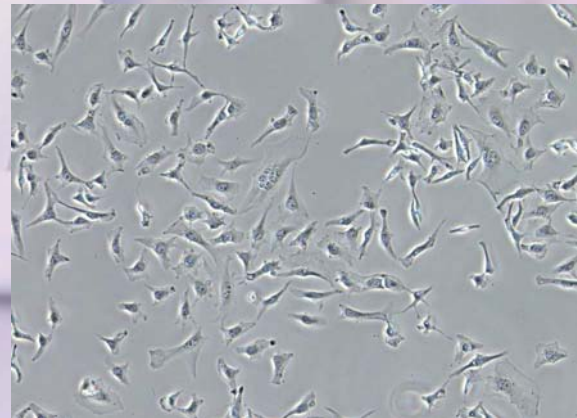
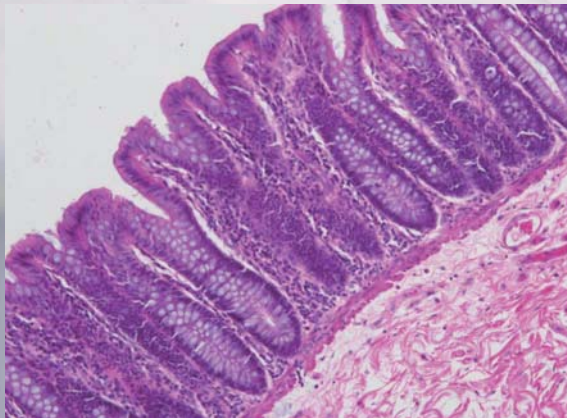

High-intensity LED Eco-illumination

The newly developed Eco-illumination provides enough brightness for both phase contrast observation and simple polarizing observation. With a fly-eye lens in the illumination system, uniform brightness is provided in the entire field of view. LEDs are environmentally friendly, consume less power than halogen lamps, and last approximately 60,000 hours, reducing costs and the need for frequent lamp replacement. The color temperature does not change when magnification is changed. A halogen illumination model is also available.

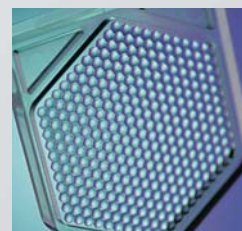

Fly-eye lens

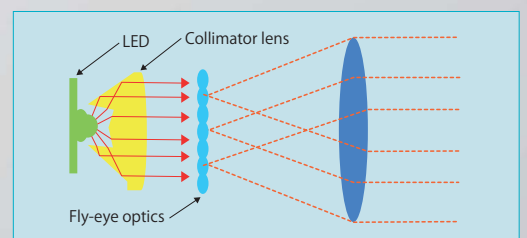
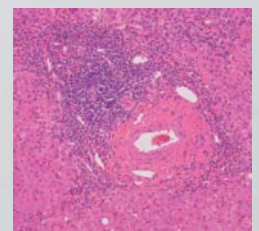

This compact small-sized clinical and laboratory microscope uses newly developed high-intensity LED illumination. The long-life LED illuminator is environmentally friendly as it reduces the need for frequent lamp replacement. A halogen illumination model is also available.

The ECLIPSE E200 uses Nikon's CFI60 optical system—highly-acclaimed infinity corrected optics used in Nikon research microscopes. The result is stunningly sharp and clear images with less chromatic aberration.

With the ECLIPSE E200, Nikon has designed a simple and easy-to-use system that reduces fatigue from use over long periods. With a robust structure and anti-mold design, the ECLIPSE E200 offers high quality and accuracy that can be retained for years even in hot and humid environments.

The ECLIPSE E200 offers exceptional operability and durability, and high-quality images. It can be used for various purposes, such as educational, clinical laboratory use and basic research.



ECLIPSE E200-F (model with field diaphragm)

ECLIPSE E200

Superb infinity optics, plus ergonomic touches



CFI60 optical system

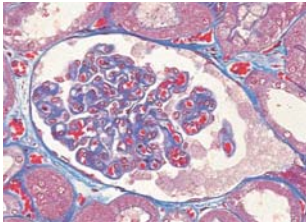
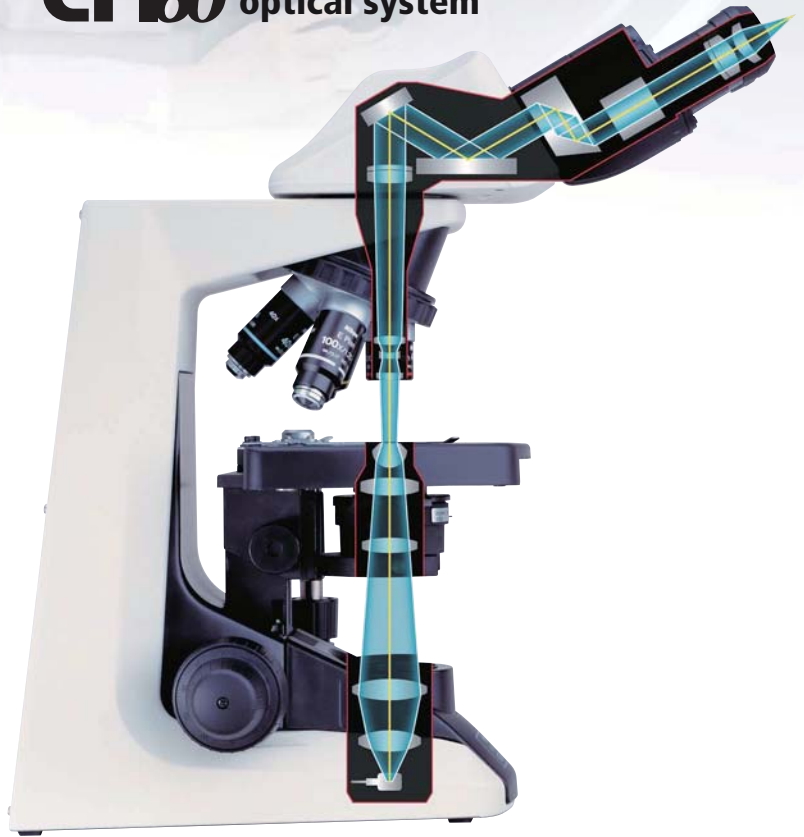

The CFI60 optical system combines Nikon's renowned CF optical design with infinity optics to overcome the limitations of the traditional infinity design. CFI60 optics

provide longer working distances and higher NA's. These optics deliver startlingly clear images at any magnification because chromatic aberrations and curvature of field are both corrected over the entire field of view when the field number is 20 mm. Nikon developed dedicated CFI E Plan Achromat objectives exclusively for the E200. Also, you can use other higher-grade objectives available for the ECLIPSE series whenever your laboratory situation calls for it.

Anti-mold design

Mold is a formidable enemy of microscopes. Before you know it, it can begin growing on the interior optical surfaces of the microscope and ruin performance. Using anti-mold paint, plus anti-mold agent sealed at critical places inside the microscope, the ECLIPSE E200 is designed to resist mold growth. In tests, an anti-mold treated unit was able to resist the growth of mold for three consecutive years at an average temperature of 30 °C (86 °F) and 80 % humidity.

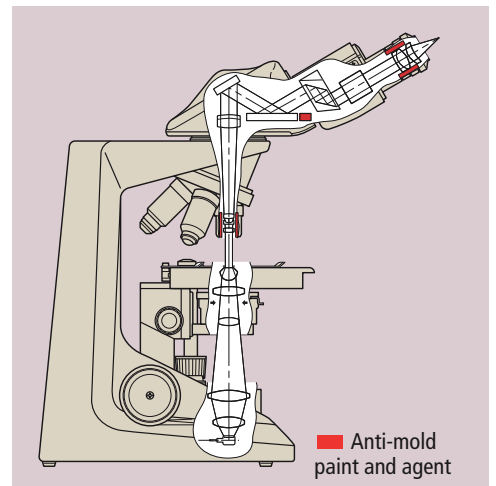

Ergonomic design equals comfortable operation

Comfort is ensured allowing long hours of use, thanks to Nikon's thoughtful ergonomic design. This is the same design incorporated into Nikon's other laboratory and research-grade ECLIPSE series microscopes.

For example, the focus knob and the stage handle are located equidistant from the operator, permitting one-handed operation in a natural posture without twisting the shoulders. Because these controls are low positioned, you can operate the microscope while resting your arms comfortably on the desk. Moreover, the low-profile stage makes exchange of specimen slides easy, while the low inclination angle tube provides comfortable viewing.

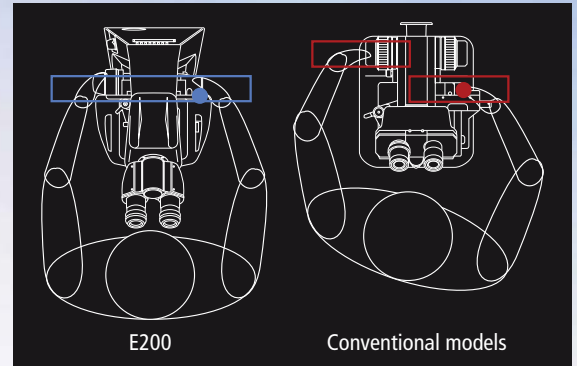

Comparison of the positions of the stage handle and focus control knob

Ergonomic binocular tube

With this option, users can adjust not only the tube tilt angle, but the eyepiece length to suit their build, eliminating discomfort and strain during long hours of observation. A camera can be attached using the DSC port.

*Use of this accessory in combination with other equipment may produce darker images around the periphery.

*Must be attached directly to the main body.



View angle is adjustable by 10° to 30°.



Eyepiece length can be extended by up to 40 mm.



E200 configured with an ergonomic binocular tube.

Eye-level riser

Up to two eye-level risers can be mounted to raise the height of the eyepoint—25 mm each for a total of 50 mm.

Robust, vibration resistant construction

One-piece construction from arm to base, a stage design where its up/down mechanism is located in the base, plus a wide footprint of 188.5 mm across the back all provide greater rigidity and resistance to vibrations, contributing to superior images.

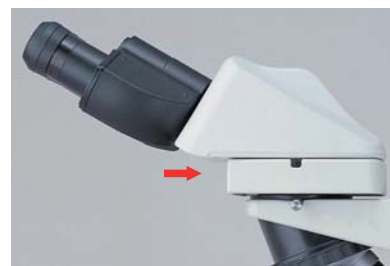

Design ideas that ensure superb optical quality and incre

CFI60 objectives

Nikon's exclusive CFI60 objectives provide numerous benefits: longer working distances, high numerical apertures, flat images over the entire field of view with virtually no curvature of field when the field number is 20 mm. To match your laboratory requirements, the E200 provides a wide selection of objectives to choose from. These include the CFI E Plan Achromat objectives developed for the E200 or other higher-grade ECLIPSE series objectives.



CFI E Plan Achromat objectives

Tube

The Siedentopf-type tube is inclined at 30° to ensure comfortable viewing in a natural posture. Designed for use by operators with different builds, this tube has a narrow minimum interpupillary distance of 47 mm, while the eyepoint height can be raised 34 mm when interpupillary distance is 64 mm by simply swinging the front part of the tube up 180°. For extremely tall users, eye-level risers are available to customize the microscope.



Low position



High position



E2-TB Binocular Tube



E2-TF Trinocular Tube

*Eyepieces are optional.

Eyepieces

The E200's eyepieces feature a wider field of view for a microscope of this class and are available in 10x (F.O.V. 20) and 15x (F.O.V. 12) types. These eyepieces also feature built-in diopter adjustment that allows the operator to adjust diopters separately for the right and left easily. In addition, these eyepieces accept measuring reticles that will always be in sharp focus with the specimen. Moreover, they can be locked preventing theft and eliminating the possibility of damage during transit.



F.O.V. 20 (E200)



F.O.V. 18 (conventional model)

ased ease of use

Refocusing stage

Nikon has created a unique innovation. The Refocusing Stage eliminates the need to refocus the image manually, making specimen handling safer and easier. In this unique design, the stage can be instantly dropped by pushing it down to exchange specimens or oil the slide, then returns to the original position as soon as the hand is removed. The wide stage surface can accommodate two slide glasses at the same time.

In addition, this stage has an array of features including:

- Increased resistance to vibrations due to the design of the in-base focus mechanism
- Low-profile design that creates more space around the objective for increased freedom in specimen handling and easier operation
- A belt-drive mechanism to eliminate the projection of the rack at the edge of the stage for better ergonomics and smoother movement
- Removable specimen holder for fast hand scanning of slides
- Improved XY cross travel, providing the comfort and feel similar to Nikon's higher grade ECLIPSE series microscopes

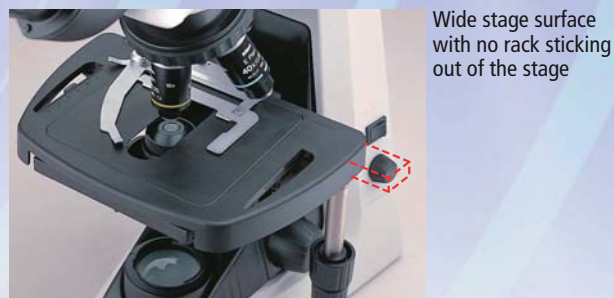

Upper limit stopper

When using short-working-distance objectives such as 40x or greater, you can set the upper limit of the stage movement, so that the objective doesn't hit the specimen slide, protecting both from damage. Thanks to this feature, even novices or operators who need to change slides often can perform their job easily and quickly. The limit height can be set in two levels using a stopper bolt—either at the standard position or 2 mm lower. This feature is very useful except when extraordinarily thick specimens are used.

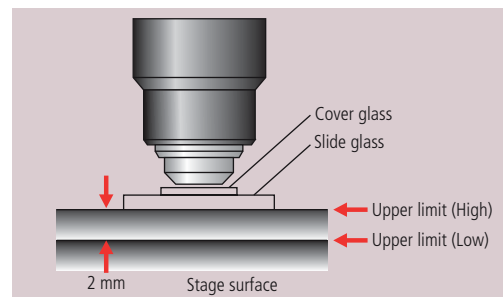

Revolving nosepiece

A reversed-type nosepiece creates more space at the front of the stage, making handling of specimen slides fast and easy. In addition, the CFI60 optical design eliminates extra optical elements in the nosepiece for enhanced image sharpness. Another advantage of CFI60 objectives is that their increased objective lengths and longer working distances provide more working space around the nosepiece.



Condenser

Although the stage is low-positioned for comfort, there is ample space around the condenser for easy access. The condenser also features an aperture diaphragm that comes complete with position guide markings for respective E Plan objectives to make operation quick and easy.



Safe and easy halogen lamp replacement

Lamp replacement is now made even easier by simply opening the lens unit cover and replacing the lamp.



Field diaphragm model available

The E200-F has a built-in field diaphragm that allows the use of Koehler illumination. It features a field lens unit with a field diaphragm that has position guide markings for respective objectives to allow easy setting of optimal apertures.



Field diaphragm with position guide markings



E200-F

A wealth of accessories to broaden the range of microscopic applications

Brightfield microscopy

A dedicated Abbe condenser is available for brightfield observation. A blue filter enabling natural color observation can be attached to the condenser.



E2 Abbe Condenser

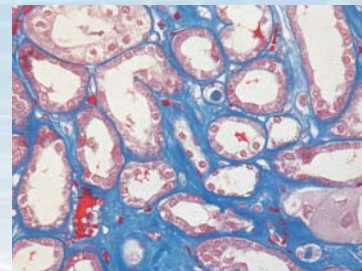

Phase contrast microscopy/darkfield microscopy

Phase contrast observation at 10x, 20x and 40x is possible with a single phase annulus slider. The aperture diaphragm automatically opens when the slider is inserted into the condenser. A phase contrast slider for 100x observation is also available.

Darkfield observation up to 40x is possible with the E2 Phase Condenser.



- ① GIF Filter
- ② Centering Telescope
- ③ E2 Phase Condenser
- ④ Phase Contrast Slider 10x-40x
- ⑤ Phase Contrast Slider 100x
- ⑥ Darkfield Slider

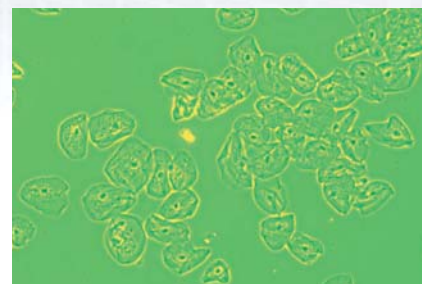

CFI Achromat DL objectives for phase contrast

Epi-fluorescence microscopy

The E200-dedicated epi-fluorescence attachment is available for users who want to begin fluorescence observation. Although affordably priced, this attachment allows comprehensive epi-fluorescence as well as UV excitation observations.



Epi-fluorescence accessories

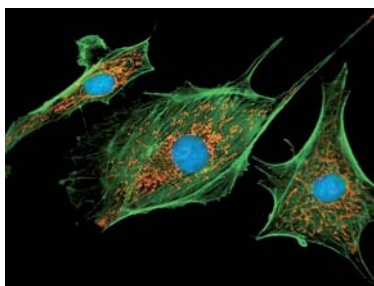

Simple polarizing microscopy

This method is ideal for observing amyloid and crystals. To set up, install the polarizer over the field lens and the analyzer.



Simple Polarizing Set C

Teaching heads

Face-to-face* and side-by-side teaching heads are available.

*Not recommended for use in conjunction with a photomicrographic system, because it makes the microscope top-heavy.



Digital Sight series camera system

When the trinocular tube is used, a digital camera can be attached.* The DS-Fi2-L3, a color camera head combined with a standalone control unit, enables focusing and viewing of images on the built-in 8.4-inch LCD monitor without the need for a PC. The optimum imaging conditions that match the observation technique in use can be automatically set by selecting the appropriate "scene mode" icon on the touch panel. Storing optimal images is easy.

*With a 4x objective, the image may show uneven illumination depending on the camera used.



Drawing tube

Allows accurate sketching of the image being observed



Object marker

Allows the point of interest within a specimen to be marked with ink

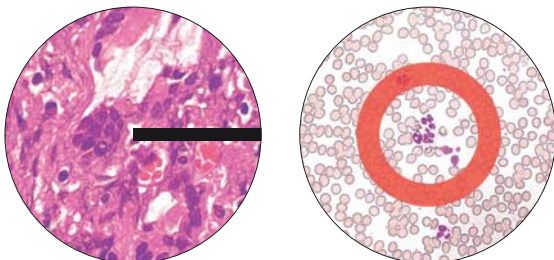

Plastic storage case

The rugged, lightweight storage case is handy for transporting and storing the E200.



ND filter for objectives (ND3)

When this filter is used in combination with a 4x or 10x objective, image brightness can be adjusted to nearly equal to that of a 40x objective.

System diagram

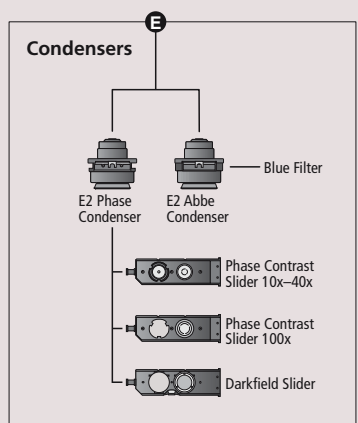
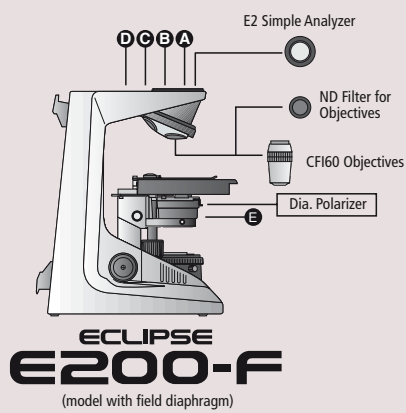
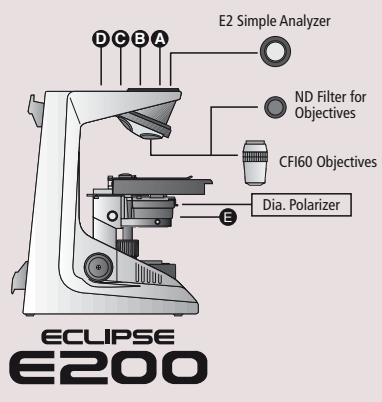
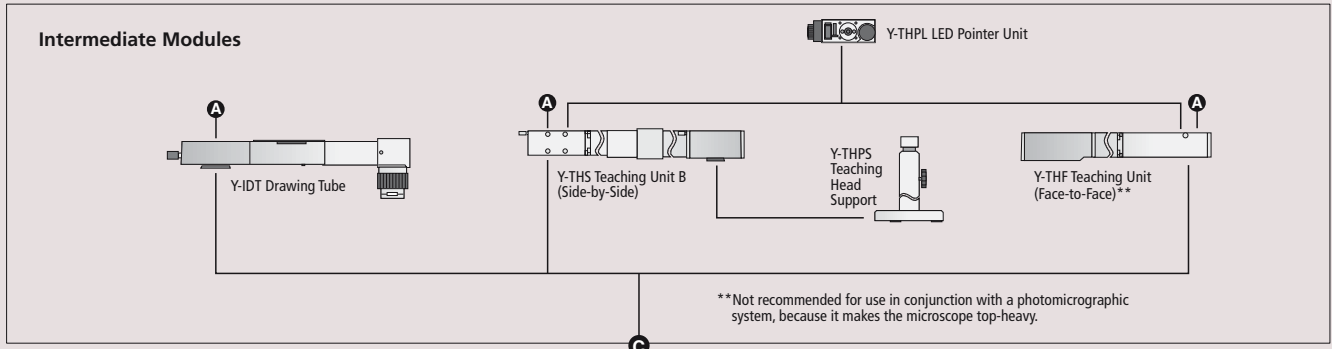
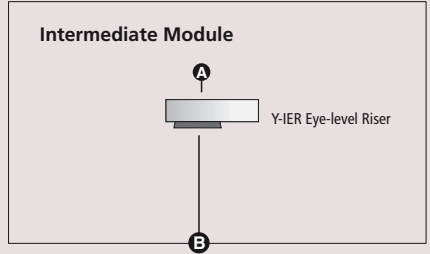
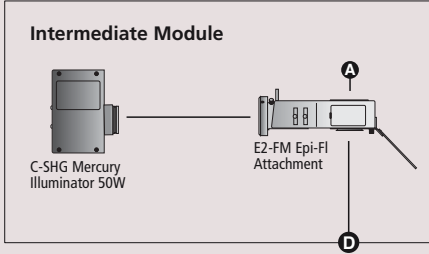
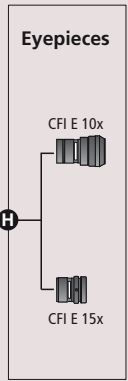
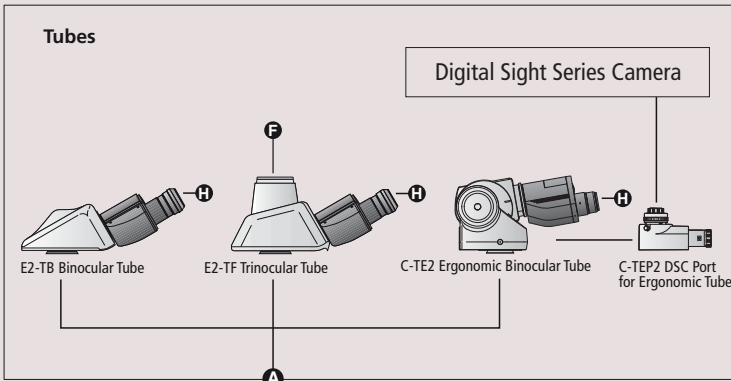
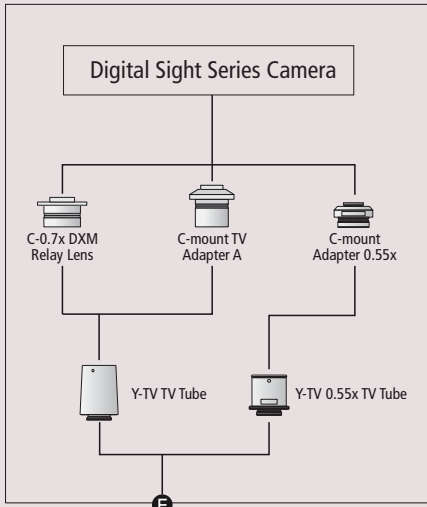

Both LED illumination and halogen illumination models are available.

Specifications

Main body	
Optical system	CFI60 Infinity Optical System, Parfocal distance: 60 mm
Illumination	High luminescent white LED illuminator (Eco-illumination) 6V20W/6V30W halogen lamp, Compliant multi-voltage (100 V-240 V)
Eyepieces (F.O.V.)	<ul style="list-style-type: none"> • CFI E 10x (20 mm) • CFI E 15x (12 mm)
Focusing	Coaxial coarse/fine focusing, Right: fine, Left: coarse/fine, Focusing stroke: 26.5 mm, Coarse: 37.7 mm/rotation, Fine: 0.2 mm/rotation, Coarse motion torque adjustable, Refocusing function
Tubes	<ul style="list-style-type: none"> • E2-TB Binocular Tube • E2-TF Trinocular Tube, Eyepiece/Port: 100/0, 0/100, 360° rotatable • C-TE2 Ergonomic Binocular Tube, Inclination: 10–30 degrees, Extension: up to 40 mm
Nosepieces	Quadruple nosepiece (within main body)
Stages	Rectangular stage (within main body), with specimen holder, Cross travel: 78 (X) x 54 (Y) mm
Objectives (NA / W.D., mm)	<ul style="list-style-type: none"> • CFI E Plan Achromat 4x (0.10 / 30) • CFI E Plan Achromat 10x (0.25 / 7.0) • CFI E Plan Achromat 40x (0.65 / 0.65) • CFI E Plan Achromat 100x oil (1.25 / 0.23) CFI Achromat DL and other higher-grade CFI60 objectives can be used.
Condensers	<ul style="list-style-type: none"> • E2 Abbe Condenser NA 1.25, Aperture diaphragm with position guide markings for respective CFI E Plan objectives • E2 Phase Condenser NA 1.25, Aperture diaphragm with position guide markings for respective CFI Achromat DL objectives
Observation methods*	Brightfield, Epi-fluorescence, Darkfield, Phase contrast, Simple polarizing
Intermediate attachment**	<ul style="list-style-type: none"> • E2-FM Epi-fluorescence Attachment, 2 filter cubes mountable • Y-THS Teaching Unit B (Side-by-Side) • Y-THF Teaching Unit (Face-to-Face) • Y-IDT Drawing Tube • Y-IER Eye-level Riser
Power consumption (max.)	Normal value: 3 W (LED model), 41 W (halogen model)
Weight (approx.)	7.3 kg (Binocular standard set)

*Observations except brightfield require optional accessories. **Maximum intermediate space 50 mm

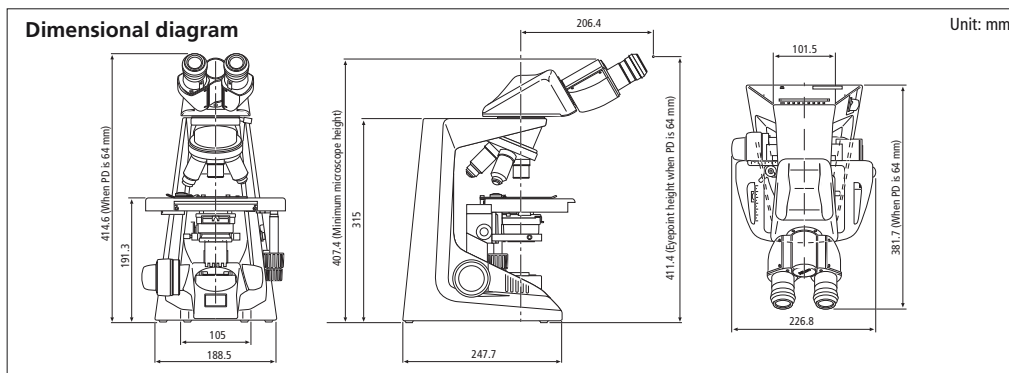

Specifications and equipment are subject to change without any notice or obligation on the part of the manufacturer. December 2013 ©2000-13 NIKON CORPORATION



Monitor images are simulated.

Company names and product names appearing in this brochure are their registered trademarks or trademarks. N.B. Export of the products* in this brochure is controlled under the Japanese Foreign Exchange and Foreign Trade Law. Appropriate export procedure shall be required in case of export from Japan.

*Products: Hardware and its technical information (including software)



ISO 9001 Certified for NIKON CORPORATION
Microscope Solutions Business Unit
Industrial Metrology Business Unit

ISO 14001 Certified for NIKON CORPORATION



 ryf	Ryf AG Bettlachstrasse 2 2540 Grenchen tel 032 654 21 00 fax 032 654 21 09 www.ryfag.ch
----------------	---