



Product Information  
Version 1.1

## ZEISS Primo Star iLED

Your Fluorescence Microscope to Quickly Detect Tuberculosis

ryf ag  
**ryf**  
Ryf AG  
Bettlachstrasse 2  
2540 Grenchen  
tel 032 654 21 00  
fax 032 654 21 09  
[www.ryfag.ch](http://www.ryfag.ch)



We make it visible.

# Fluorescence or Brightfield – The Choice Is Yours.

- › In Brief
- › The Advantages
- › The Applications
- › The System
- › Technology and Details
- › Service

Your Primo Star iLED fluorescence microscope takes a fresh approach to robustness, energy efficiency, and ease of use: Primo Star iLED is the cost-effective solution in the fight against tuberculosis. You can easily and reliably detect Mycobacterium tuberculosis either using fluorescence or brightfield illumination.

Primo Star iLED is the result of cooperation between ZEISS and the Foundation for Innovative Diagnostics (FIND). This microscope combines all of ZEISS' experience in light microscopy and has been specially adapted to detect tuberculosis under rural conditions.



▶ Click here to view this video  
*Staining Mycobacterium tuberculosis with auramine Sample: courtesy of Dr. H. Hoffmann, WHO – Supranational Reference Laboratory IML, Gauting, Germany*



# Simpler. More Intelligent. More Integrated.

- › In Brief
- › **The Advantages**
- › The Applications
- › The System
- › Technology and Details
- › Service

## Your Complete Solution for the Detection of Tuberculosis with LED Fluorescence

Use your Primo Star iLED microscope as a complete solution to detect tuberculosis with LED fluorescence. You can easily change between fluorescence and brightfield. Your Primo Star iLED is out-standingly well suited for your laboratory and routine applications. Your images will show excellent contrast, especially if you work with specimens stained with auramine-rhodamine. With Primo Star iLED you can also investigate infectious diseases such as malaria and sleeping sickness.

## Detect Mycobacteria up to Four Times Faster

Your Primo Star iLED's fluorescent excitation causes mycobacteria stained with auramine-rhodamine to light up greenish yellow in front of a dark background. You use the 40x objective lens of your Primo Star iLED and detect *Mycobacterium tuberculosis* up to four times faster than when using brightfield. Using brightfield, you look for mycobacteria stained with Ziehl-Neelsen dye, using a 100x oil immersion objective lens.

## ZEISS Supports the Worldwide Fight Against Tuberculosis

Robert Koch worked with ZEISS objectives. In 1882, he discovered *Mycobacterium tuberculosis*. Primo Star iLED continues this tradition. Primo Star iLED is the result of our joint project with the Swiss Foundation for Innovative Diagnostics (FIND). It is a microscope developed especially for tuberculosis investigations. As a customer from one of the countries most heavily affected by tuberculosis, Primo Star iLED is available for you at a particularly low price. ZEISS is a member of the Stop TB Initiative.

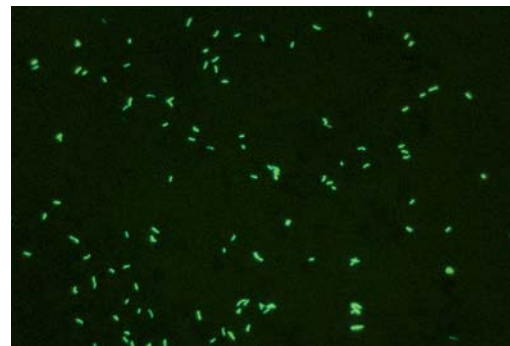

*Mycobacterium tuberculosis*, stained with Auramine O.  
Courtesy of Dr. H. Hoffmann, WHO – Supranational Reference Laboratory IML, Gauting, Germany



The distribution of tuberculosis around the world

## Expand Your Options

- › In Brief
- › **The Advantages**
- › The Applications
- › The System
- › Technology and Details
- › Service

### **Primo Star iLED – Precise Results in Every Environment**

Your Primo Star iLED is very easy to use. The LED illumination helps here. Working with LED-fluorescence you don't need time to warm up or cool down. You don't need to align the bulb, and its long life saves costs while it consumes comparatively little energy.

Working in the field, you have the option of working in brightfield with a mirror and sunlight. Ergonomic eyecups keep ambient light out so that you get high-contrast fluorescence images even without a darkroom.

In remote areas with fluctuating or no electricity, use your Primo Star iLED's battery pack.

You can transport your Primo Star iLED microscope conveniently and safely in its practical trolley case. With Primo Star iLED, you get a series of objectives (D = 0), which have been optimized for your sample preparation without a cover slip.



# Tailored Precisely to Your Applications

- › In Brief
- › The Advantages
- › **The Applications**
- › The System
- › Technology and Details
- › Service

Typical Applications, Typical Specimens	Task	ZEISS Primo Star iLED Offers
<i>Mycobacterium tuberculosis</i>	Quick detection of pathogens	<p>Quick switching from brightfield excitation to fluorescence illumination using a 40x objective lens with a larger object field: pathogens can be detected up to four times faster, the sensitivity in detecting pathogens increases by 10%.</p> <p>It is easy to detect mycobacteria using fluorescence contrast: after staining with auramine O, the particles light up greenish yellow in front of a dark background.</p>
	Flexible detection	<p>There is a battery pack for use without an electricity supply in remote regions or regions with poor infrastructure.</p> <p>Fluorescence is excited with an energy-saving LED. If the electricity supply is unstable or fails, the microscope can be operated for a few hours using batteries.</p> <p>The special eyecups almost completely exclude ambient light, making a darkroom superfluous.</p> <p>An antifungal treatment is applied to all optical components. Even under extreme climatic conditions, this coating permits optimal use and offers permanent protection.</p>
<b>Sleeping sickness</b>	<p>The <i>Trypanosoma brucei gambiense</i> pathogen can be quickly detected</p> <p><i>Trypanosoma brucei rhodesiense</i>, above all in east Africa</p> <p><i>Trypanosoma cruzi</i> (Chagas' disease) in South America</p>	<p>Primo Star iLED enables microscopic detection of pathogens, for example in a blood smear or cerebrospinal fluid sediment. The spindly trypanosomes, their long flagella, and the undulating membrane can be clearly recognized with good contrast in brightfield illumination. With fluorescence, the trypanosomes – after being stained with acridine orange – light up orange in front of a dark background.</p>
<b>Malaria</b>	<p>The <i>Malaria tropica</i>, <i>Malaria tertiana</i>, and <i>Malaria quartana</i> pathogens can be quickly detected</p>	<p>Malaria pathogens can be detected in brightfield illumination with Primo Star iLED by making the various stages of maturity of the plasmodia visible. Fluorescence-based investigations are also possible after staining with acridine orange, for example.</p>



# ZEISS Primo Star iLED at Work

- › In Brief
- › The Advantages
- › **The Applications**
- › The System
- › Technology and Details
- › Service

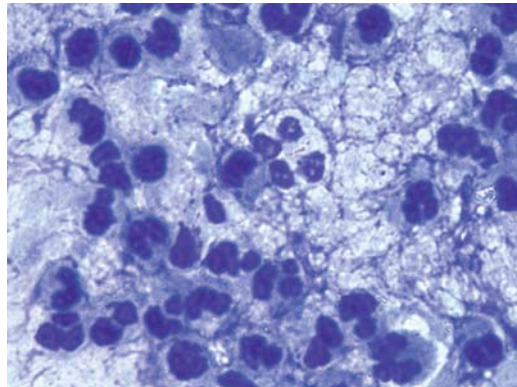

*Mycobacterium tuberculosis*, investigation after Ziehl-Neelsen staining; the purple colored mycobacteria are hard to see in the microscopic image

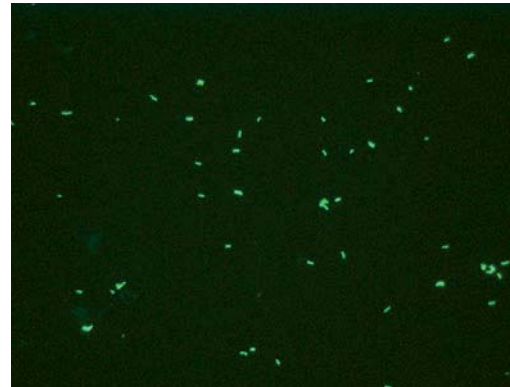

In the fluorescence contrast process, after staining them with auramine O, the mycobacteria are clearly visible as greenish yellow particles in front of a dark background



*Trypanosomas brucei* – the African sleeping sickness pathogen – after staining with acridine orange, using fluorescence contrast

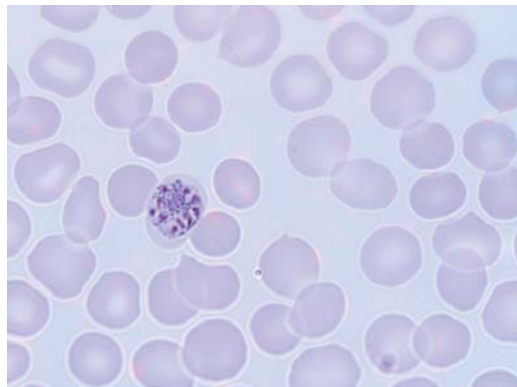

1. *Plasmodium malariae*, daisy-head stage



2. *Plasmodium vivax* showing characteristic Schüffner's dots

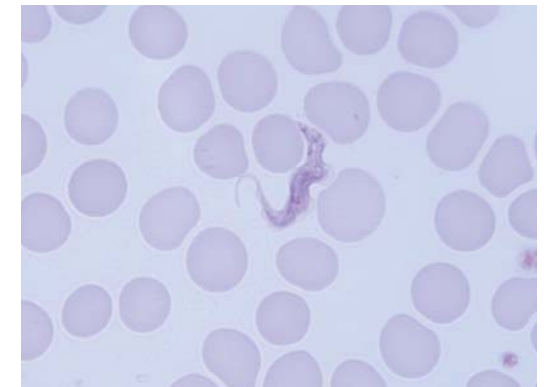

3. *Trypanosoma brucei gambiense* with undulating membrane

Andrea Michelsen, general manager and chairwoman of the Deutscher Verband Technischer Assistentinnen/Assistenten in der Medizin e.V., head of the central laboratory of the Ortenau Klinikum Lahr-Ettenheim, Germany

# Your Flexible Choice of Components

- › In Brief
- › The Advantages
- › The Applications
- › **The System**
- › Technology and Details
- › Service

## 1 Microscopes

- Primo Star iLED (fixed Köhler) with reflected fluorescent illumination

## 2 Objectives

- Plan-ACHROMAT with magnifications of 10x, 20x, 40x and 100x optimized for specimens without cover slip (D = 0)

## 3 Illumination

Transmitted light

- LED Reflected light
- Fluorescence module with 455 nm LED

## 4 Accessories

- Transport case
- Rechargeable battery pack
- Illuminating mirror



# System Overview ZEISS Primo Star iLED

- › In Brief
- › The Advantages
- › The Applications
- › **The System**
- › Technology and Details
- › Service

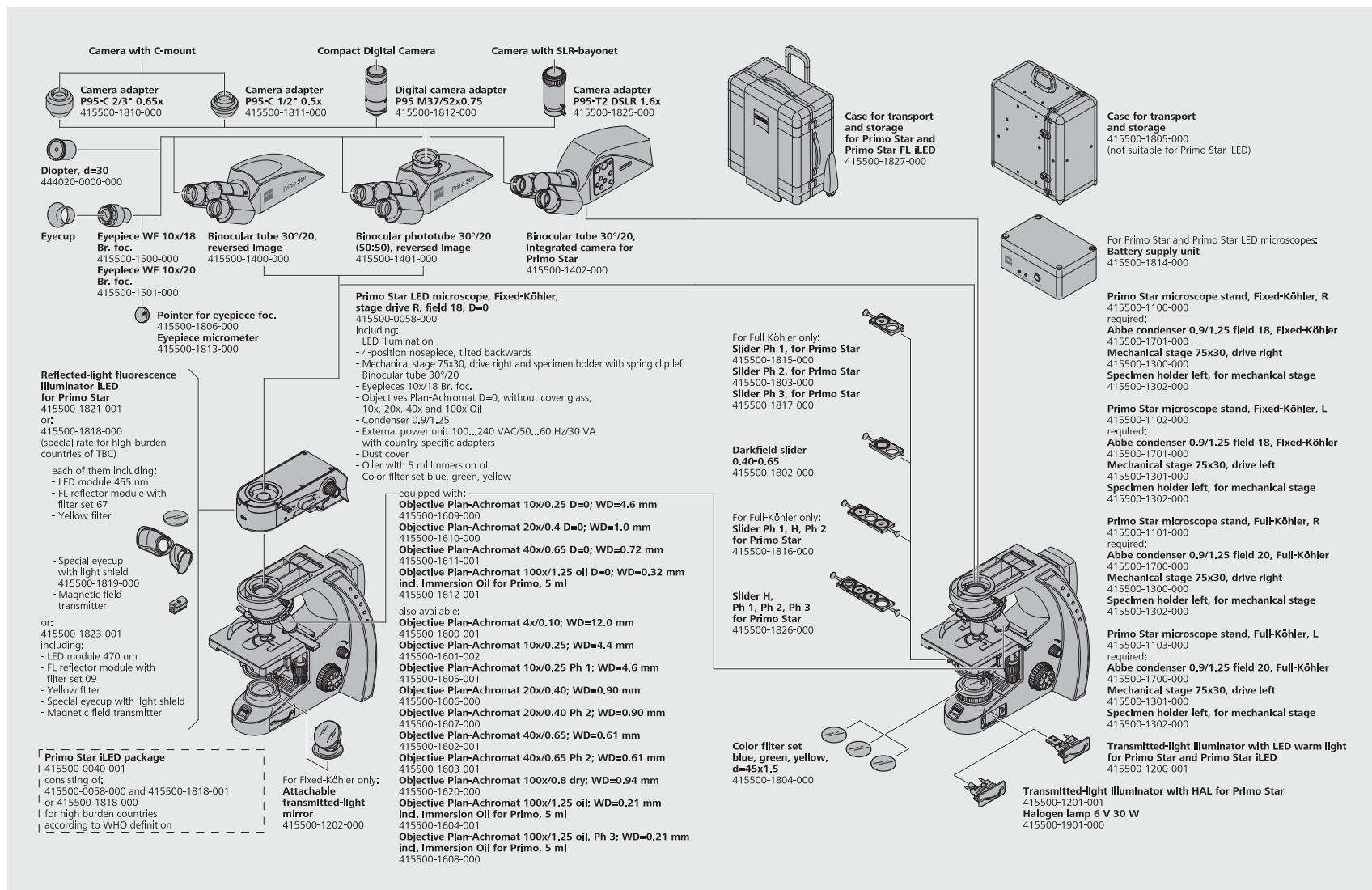



# Technical Specifications

- › In Brief
- › The Advantages
- › The Applications
- › The System
- › **Technology and Details**
- › Service

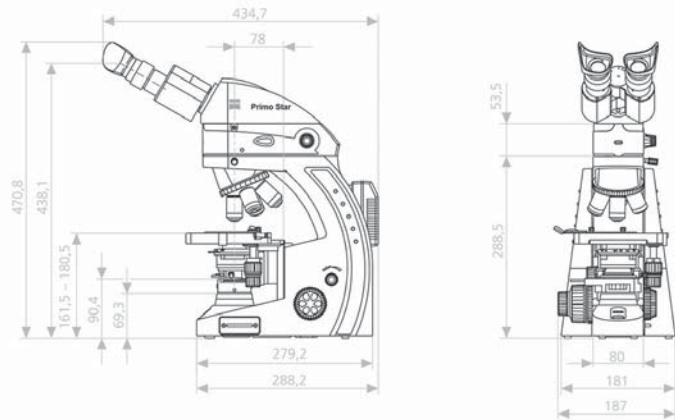

## Dimensions (width × depth × height)

Stand with reflected fluorescent illumination	Approx. 190 × 410 × 449 mm
---	----------------------------

## Weight

Primo Star iLED	Approx. 9.6 kg
-----------------	----------------

## Ambient Conditions

### Transportation (in packaging)

Permissible ambient temperature	-40°C to +70°C
---------------------------------	----------------

### Storage

Permissible ambient temperature	+10 °C to +40 °C
Permissible relative humidity (without condensation)	Max. 75% at 35 °C

### Operation

Permissible ambient temperature	+10 °C to +40 °C
Permissible relative humidity (without condensation)	Max. 75% at 35 °C
Atmospheric pressure	800 hPa to 1,060 hPa

# Technical Specifications

- › In Brief
- › The Advantages
- › The Applications
- › The System
- › **Technology and Details**
- › Service

<b>Technical Specifications</b>	
Protection class	II
Protection type	IP20
Electrical safety	According to DIN EN 61010-1 (IEC 61010-1) and in accordance with CSA and UL standards
Pollution degree	2
Overvoltage category	II
Radio interference suppression	According to DIN EN 61326-1 and DIN EN 61326-2-6
Power supply	100 to 240 V (±10%), thanks to its worldwide power supply unit, the voltage does not have to be adjusted
Power frequency	50/60 Hz
Power consumption	70 VA; secondary voltage from external 12 V power supply unit
Output of the plug-in power supply unit	12 V DC; max. 2.5 A
Microscope 12 V/6 V DC	Adjustable 1.5 V to 6 V
LED hazard class of entire device	2, pursuant to DIN EN 62471
<b>Light Sources</b>	
<b>Halogen Lamp</b>	HAL 6 V, 30 W
Light source adjustment range	Fully adjustable between 1.5 V and 6 V DC
Color temperature at 6 V	2,800 K
Luminous power	280 lumens
Average life	1,000 hours
Illuminated area	1.5 × 3 mm
<b>LED Illumination</b>	
Constant color temperature, independent of brightness from	White-light LED, peak wavelength 440 nm, LED hazard group 1 according to DIN EN 62471 (low risk)
Homogeneous image field illumination	3,200 K
Suitable for objectives with magnifications from	20 mm diameter
Analog brightness adjustment from	4× to 100× Approx. 15 to 100%
<b>LED Module</b> (reflected fluorescent illumination)	Max. 40 mW, 365 – 625 nm; LED hazard group 2 according to DIN EN 62471
<b>Battery Supply unit</b> (accessory)	
Rechargeable battery	Fuses according to IEC 127 T4.0 A/H
Type	D cell – standard commercially available, NiCd or NiMH with 1.2 V
Capacity	At least 5,000 to max. 9,000 mAh
Number of battery supply units	Five items
Operating duration	Several hours, depending on the capacity of the batteries

# Technical Specifications

- › In Brief
- › The Advantages
- › The Applications
- › The System
- › **Technology and Details**
- › Service

## Optical and Mechanical Data

### Stand with stage focus

Using rough adjustment	45 mm/rev
Using fine adjustment	0.5 mm/rev
Total travel	15 mm

Switching objectives	Manually using four-way objective revolver
----------------------	--

Objectives	Range of infinite focus objectives with W 0.8 screw thread
------------	--

### Eyepieces

30 mm diameter	
With visual field number 18	PL 10× / 18 Br. foc.
With visual field number 20	PL 10× / 20 Br. foc.

### Object stage

XY stage, 75 × 30 right/left	
Dimensions (width × depth)	140 × 135 mm
Range of adjustment (width × depth)	75 × 30 mm
Coaxial drive	Optionally right or left
Verniers	Can be read off from left
Object holder	With spring lever left

Abbe condenser 0.9/1.25; fixed Köhler	For Vobj 4× to 100×
---------------------------------------	---------------------

Abbe condenser 0.9/1.25; full Köhler	For Vobj 4× to 100×
--------------------------------------	---------------------

### Binocular Tube 30°/20

Maximum field of view	20
Eyepiece distance (pupil distance)	Adjustable from 48 to 75 mm
Viewing angle	30°
Viewing height	380 to 415 mm
Visual output	Tube factor 1×

### Binocular Camera Tube 30°/20

Maximum field of view	20
Eyepiece distance (pupil distance)	Adjustable from 48 to 75 mm
Viewing angle	30°
Viewing height	380 to 415 mm
Visual output	Tube factor 1×
Photo/video output	Tube factor 1×, interface 60 mm
Fixed split	50% vis/50% doc

Illuminating mirror	With flat surface and spherical surface with $f' = 75$ mm
---------------------	---

An antifungal treatment is applied to all optical components to prevent fungal growths.

# Count on Service in the True Sense of the Word

- › In Brief
- › The Advantages
- › The Applications
- › The System
- › Technology and Details
- › **Service**

Because the ZEISS microscope system is one of your most important tools, we make sure it is always ready to perform. What's more, we'll see to it that you are employing all the options that get the best from your microscope. You can choose from a range of service products, each delivered by highly qualified ZEISS specialists who will support you long beyond the purchase of your system. Our aim is to enable you to experience those special moments that inspire your work.

## **Repair. Maintain. Optimize.**

Attain maximum uptime with your microscope. A ZEISS maintenance contract lets you budget for operating costs, all the while avoiding costly downtime and achieving the best results through the improved performance of your system. Choose from service contracts designed to give you a range of options and control levels. We'll work with you to select the service program that addresses your system needs and usage requirements, in line with your organization's standard practices.

Our standard preventative maintenance and repair on demand contracts also bring you distinct advantages. ZEISS service staff will analyze any problem at hand and resolve it – whether using remote maintenance software or working on site.

## **Enhance Your Microscope System**

Your ZEISS microscope system is designed for a variety of updates: open interfaces allow you to maintain a high technological level at all times. As a result you'll work more efficiently now, while extending the productive lifetime of your microscope as new update possibilities come on stream.

Please note that our service products are always being adjusted to meet market needs and may be subject to change.



*Profit from the optimized performance of your microscope system with a ZEISS service contract – now and for years to come.*

>> [www.zeiss.com/microservice](http://www.zeiss.com/microservice)

ryf ag  Ryf AG  
Bettlachstrasse 2  
2540 Grenchen  
tel 032 654 21 00  
fax 032 654 21 09  
[www.ryfag.ch](http://www.ryfag.ch)



We make it visible.