



CNC Video Measuring System

# NEXIV

## VMZ-R



# NEXIV 3rd Generation, VMZ -R Series,

Created with 3 new stage platforms (3020, 4540, and 6555) and 6 new optical heads (Type 1,2,3, and 4, Type TZ and Type A)

Optical heads – Total 6 types Select the best one for your measurements.

## Type 1, 2 and 3 – Standard magnification zooming heads

Type 1 0.5x~7.5x Type 2 1x~15x Type 3 2x~30x

Type 1, 2 and 3, have Nikon 15x zoom optics with a long working distance, wide FOV (Field of View) and a high N.A. (Numerical Aperture) 0.35. All standard heads equipped with LED episcopic, diascope and inner/outer ring illuminators giving top, bottom and oblique lights with 3 different oblique angles, to make obscure edges stand out.

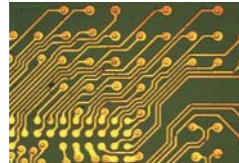

High density PCB (optical magnification 1x) Type 2 zooming head / coaxial top light

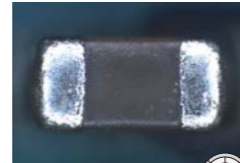

Printed circuit board (optical magnification 2x) Type 2 zooming head / 8 segment LED ring light

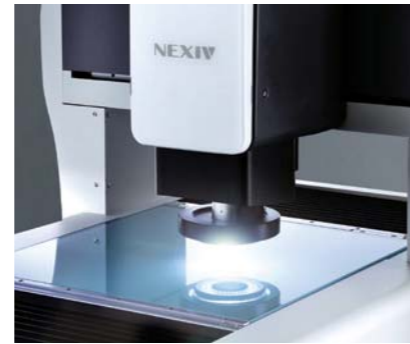

## Type 4 and TZ – High magnification zooming heads

Type 4 4x~60x Type TZ 1x~7.5x/16x~120x

Type 4 and TZ have Nikon 15x and 120x zoom optics with higher magnification and a higher N.A. 0.46. Type 4 is equipped with LED episcopic, diascope and ring illuminators, giving top, bottom and oblique lights with 50 degrees. TZ has LED episcopic, diascope and Dark Field illuminators for the main objective lens (16-120x) and LED episcopic and Dark Field illuminators for the auxiliary objective lens (1-7.5x).

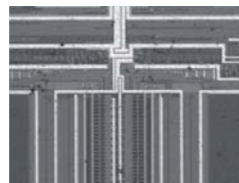

IC chip (optical magnification 8x) Type 4 zooming head / coaxial top light

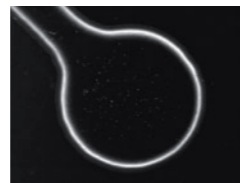

High density PCB (optical magnification 16x) Type TZ zooming head / dark field illumination

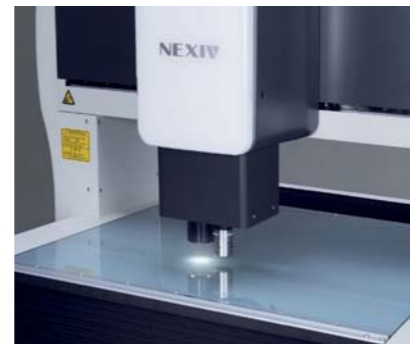

## Type A - Wide FOV zooming head

Type A 0.35x~3.5x

Type A features Nikon 10x zoom optics with the widest FOV, the longest working distance and the highest N.A. 0.11 in this low magnification range, equipped with LED episcopic, diascope and ring illuminators giving top, bottom and oblique lights.

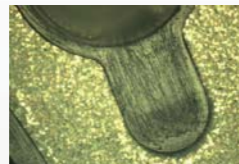

Plastic molded part (optical magnification 0.6x) Type A zooming head / coaxial top light



Resin parts (optical magnification 0.35x) Type A zooming head / 8 segment LED ring light



Stage strokes – 3 types

## 300mm(X) × 200mm(Y) × 200mm(Z) – Standard strokes

### VMZ-R 3020

Suitable for small components used for various kinds of products such as mechanical, electric, electronic, automotive, medical devices, etc.

- Type 1~3 Connectors, semiconductor packages, small PCB's, small stamped sheet metal parts, lead frames, watch components, etc.
- Type 4/TZ High density PCB's, lead frames, semiconductor packages, MEMS, probe cards, etc.
- Type A Plastic molded parts, sheet metal parts, rubber parts, mechanical parts, implant components, watch components, etc.



## 450mm(X) × 400mm(Y) × 200mm(Z) – Middle stroke

### VMZ-R 4540

Newly designed for middle size components and/or series measurements of multiple pieces on the stage.

- Type 1~3 Middle size PCB's, stamped sheet metal parts, etc.
- Type 4/TZ 300mm wafers, 300mm probe cards, etc.
- Type A Middle size mechanical parts, plastic molded parts, etc.



## 650mm(X) × 550mm(Y) × 200mm(Z) – Large stroke

### VMZ-R 6555

Suitable for large size components and/or "step-and-repeat" measurements of multiple pieces on the stage.

- Type 1~3 Large PCB's, large plastic molded parts, etc.
- Type 4/TZ High density large PCB's, etc.
- Type A Large stamped sheet metal parts, Large plastic molded parts, etc.



\* 150mm(X) × 150mm(Y) × 150mm(Z), 1000mm(X) × 800mm(Y) × 150mm(Z) and 1200mm(X) × 740mm(Y) × 150mm(Z) are available with VMR series.

Optical magnification		0.35	0.5	0.6	1	1.8	2	3.5	4	7.5	8	15	16	30	32	60	64	120		
Magnification type	Standard zooming heads	Type 1		●	●	●	●	●	●	●	●	●	●	●	●	●	●	●	●	
		Type 2				●	●	●	●	●	●	●	●	●	●	●	●	●	●	●
		Type 3					●	●	●	●	●	●	●	●	●	●	●	●	●	●
	High magnification zooming heads	Type 4								●	●	●	●	●	●	●	●	●	●	●
		Type TZ									●	●	●	●	●	●	●	●	●	●
Wide FOV zooming head	Type A	●	●	●	●	●	●	●	●	●	●	●	●	●	●	●	●	●	●	
FOV size on stage	Horizontal (mm) × Vertical (mm)		13.3 × 10.0	9.33 × 7.01	7.8 × 5.8	4.7 × 3.5	2.6 × 1.9	2.33 × 1.75	1.33 × 1.00	1.165 × 0.875	0.622 × 0.467	0.582 × 0.437	0.311 × 0.233	0.291 × 0.218	0.155 × 0.117	0.146 × 0.109	0.07 × 0.068	0.073 × 0.055	0.039 × 0.029	
		Total magnification on PC monitor		12.6	18	21.6	36	64.8	72	126	144	270	288	540	576	1080	1152	2160	2304	4320

\* Total magnification is that of video window with 640 × 480 pixels on 24 inch WUXGA monitor (1920 × 1200 pixels) recommended for VMZ-R series.

# New VMZ-R Features Include



## New zooming heads Type 4 and A, new stage strokes 450x400mm, cover your applications with a wider range.

### New zooming heads

#### • Type 4

Newly designed with optical magnification 4 to 60x, twice the magnification than that of type 3, where a high N.A. 0.46 and a long working distance of 30mm are combined. Ideal for high density specimen with tiny features to measure.



**Type 4**  
High density PCB  
(optical magnification 16x)

#### • Type A

Type A optical head has gained an excellent reputation with the VMA-2520 since 2007. It has an extremely long working distance of 73.5mm, making it comfortable and safe to work with. It also has an extremely wide FOV max. 13.3x10mm. Good for many low density specimen with big steps, deep holes, tall bosses, etc..



**Type A**  
Plastic molded part  
(optical magnification 0.35x)

### Middle XY stage strokes and an extended Z stroke

Type 1, 2 and 3 are equipped with 8 segment LED inner and outer ring illuminators enabling you to make the best illumination for making obscure edges stand out. You have a choice from 3 oblique angles, 37, 55 and 75 degrees, from any directions of 8 segments and combination of any segments and using any light intensity.

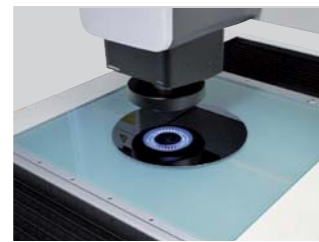

Measurement of a 300mm wafer

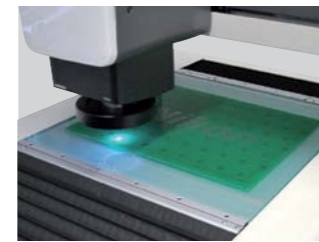

Measurement of a large PCB

## New TTL Laser AF (TTL - Through the lens)

### Type 1~3 / Type 4 / TZ

New TTL Laser AF can now detect 2 Laser beams reflected, one from top surface of an upper transparent layer, the other from its bottom surface or from the top surface of the second layer. Consequently, it can measure thickness of the transparent layer or depth to top surface of the second layer. Laser AF now has a new mode to make the optical head stop exactly on focus point and cease any further movement, passing or returning to focus point, for reducing measuring time.

#### New TTL Laser AF

It can detect 2 Laser beams reflected on 2 different surfaces.

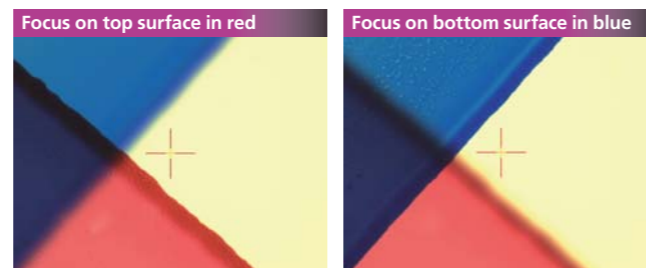
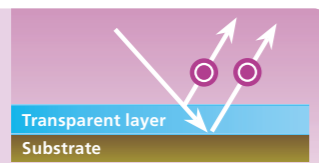

0.1mm glass plate at 8x optical magnification of Type 2 zooming head

## Software with new GUI

### Type 1~3 / Type 4 / TZ / Type A

NEXIV software is renewed with new GUI featuring Main Window, from which you can make or run teaching files, verify results or make various calibrations. With various wizards, you can make teaching files more easily in shorter time. It is equipped with NEXIV Profiler and NEXIV Report software. Please refer to page 11 and 12 for more details of the software.

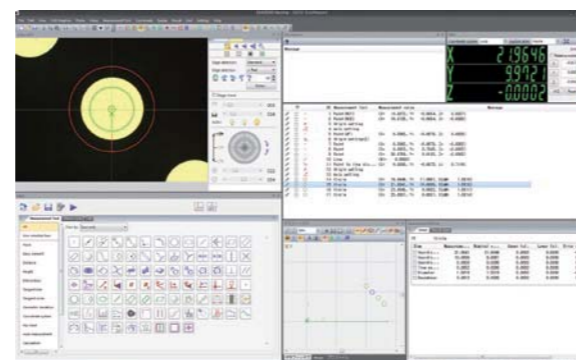

## 8 segment LED inner and outer ring illuminators

### Type 1~3

Type 1, 2 and 3 are equipped with 8 segment LED inner and outer ring illuminators, achieving the best illumination possible, revealing obscure edges stand out. You have a choice from 3 oblique angles, 37, 55 and 75 degrees, from any directions of 8 segments and combination of any segments and using any light intensity.

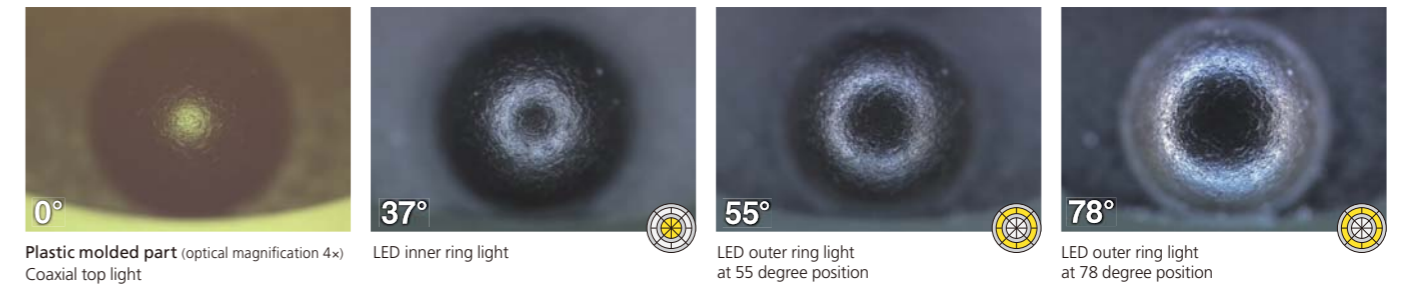

## Other new features

### Type 1~3 / Type 4 / TZ / Type A

#### Improvement of uncertainty

Nikon's new linear encoder "ModuRay" featuring a non-contact reading head that contributes to greater certainty.



#### Higher throughput

Higher data transferring speed and adoption of LED light source, that can change its intensity in a moment, compared with halogen lamp, resulting in higher throughput.

#### LED light source for all illuminators

LED light source is newly adopted for episcopic and diasopic illuminators giving top and bottom lights. LED light source features a short time for changing its intensity, a stable high color temperature regardless of its intensity, a long life and a low consumption of electric power in comparison with halogen lamp. Thus, LED light source brings you shorter measurement time and lower cost of ownership.

#### XGA camera option

You now have a choice of XGA camera with 1024 x 768 pixels in addition to conventional VGA camera with 640 x 480 pixels. XGA camera is for getting high resolution images for visual inspection, documentation, etc.. Uncertainties of systems specified in this brochure are guaranteed with both VGA and XGA cameras.

#### New joystick box

Z axis fine movement buttons are newly added on top of the joystick lever for XY axis movement and rotating knob for Z axis movement as well as 3 buttons to which your favorite 3 functions can be assign.



# Type 1, 2 and 3 – Standard magnification zooming heads



## Standard magnification zooming heads equipped with excellent Nikon optics.

The zooming heads are equipped with Nikon-designed 15x zoom optics and made exclusively for the NEXIV VMZ-R series, featuring a long working distance 50mm, a high N.A. 0.35, a low distortion, and low magnification error.

Optical magnification		0.5	1	2	4	7.5	8	15	16	30	
Magnification Type	Type 1 (0.5 to 7.5x)	0.5x	1x	2x	4x	7.5x	8x	15x	16x	30x	
	Type 2 (1 to 15x)	1x	2x	4x	8x	15x					
	Type 3 (2 to 30x)	2x	4x	8x	16x	30x					
FOV size on stage	Horizontal x Vertical (mm)	9.33 7.01	4.7 3.5	2.33 1.75	1.165 0.875	0.622 0.467	0.582 0.437	0.311 0.233	0.291 0.218	0.155 0.117	
1/3" CCD size	Horizontal x Vertical (mm)	4.8x3.6									
Video magnification		36									
Total magnification on Video Window (640 x 480 pixels)		18	36	72	144	270	288	540	576	1080	
Size of 1 pixel (micrometer)		14.7	7.36	3.68	1.84	0.98	0.82	0.48	0.46	0.24	
Size of objects on Video Window (640 x 480 pixels)	0.01x (mm)	0.18	0.36	0.72	1.44	2.7	2.88	5.4	5.76	10.8	
	0.1x (mm)	1.8	3.6	7.2	14.4	27	28.8	54	57.6	108	
	1x (mm)	18	36	72	144	270	288	540	576	1080	
Optical magnification		0.5	1	2	4	7.5	8	15	16	30	

\* Total magnification is that of video window with 640 x 480 pixels on 24 inch WUXGA monitor (1920 x 1200 pixels) recommended for VMZ-R series.

## New TTL Laser AF with 50mm working distance (TTL - Through the lens)

**NEW**

Type 1, 2 and 3 zooming heads are equipped with TTL Laser AF with a long working distance 50mm. TTL Laser AF can work and show a high repeatability, independent from magnification used. It can be used also for scanning surface by detecting a maximum of 1000 points per second. It now can also detect top and bottom surfaces of a transparent layer for measuring thickness of the transparent layer or the depth to surface of the layer under the transparent layer.

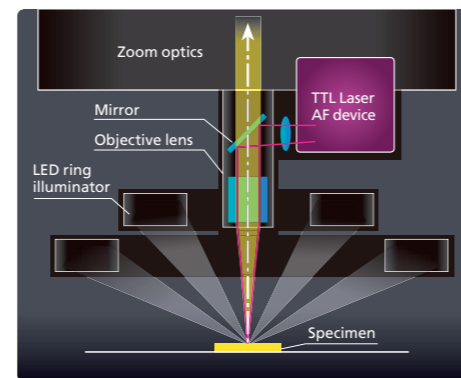

TTL Laser AF schematic

<b>Focusing mode</b>	Zooming head moves to focus point, passes it and returns to it.
<b>Trigger mode</b>	Zooming head moves to focus point and passes it and does not return to it (for reduction of measuring time).
<b>Tracking mode</b>	Zooming head moves to focus point and stops there and does not pass it (for further reduction of measuring time).
<b>Searching mode</b>	Zooming head detects 2 surfaces reflecting Laser beam and you can choose a surface to detect.

## Image Auto focus (AF)

The AF image of the VMZ-R has improved speed and repeatability with respect to the VMR series. The VMZ-R AF produces improved average height of a rough surface, depth detection of small, deep holes or steep surfaces as opposed to that obtained by a laser.

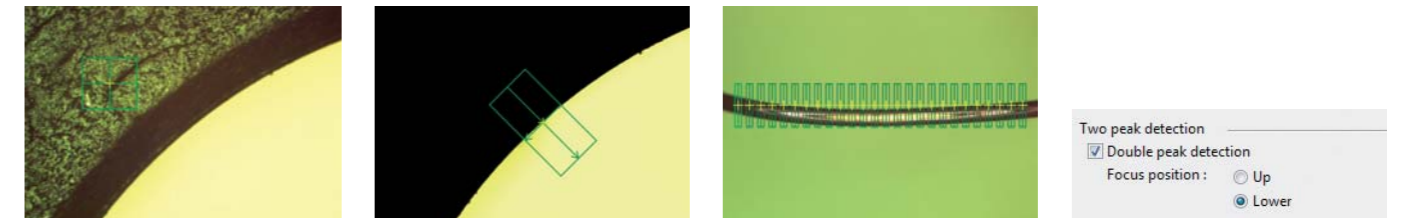

- **Surface mode**  
For focusing on surface of objects
- **Contrast mode**  
For focusing on edges contoured by bottom light
- **Multi mode**  
For getting height of multiple points in FOV
- **2 peak detection**  
For getting higher or lower focus point

## Versatile illumination designed for highlighting obscure edges

LED light sources have now replaced all the halogen light sources used on previous models. LEDs have a stable high color temperature, which does not change with intensity. This gives more natural images and shorter measurement times.

- 1 Diascopic and episcopic light control
- 2 Automatic adjustment of diascopic and episcopic light intensity
- 3 Ring light control – angle and direction
- 4 Rotation of ring light direction
- 5 Ring light intensity control



The inner 8 segment LED ring illuminator has 37 degree oblique angle to optical axis and the outer 8 segment LED ring illuminator has 55 and 78 degrees, that can easily define edges which are almost invisible to coaxial top light.

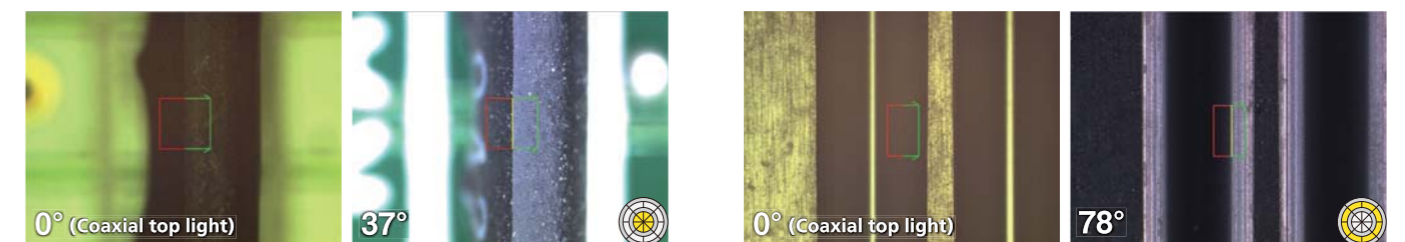

- **Coaxial top light / 37 degree oblique light** (Connector at optical magnification 5x)  
Obscure edges under coaxial top light are visible with LED ring lights.
- **Coaxial top light / 78 degree oblique light** (Drill at optical magnification 5x)

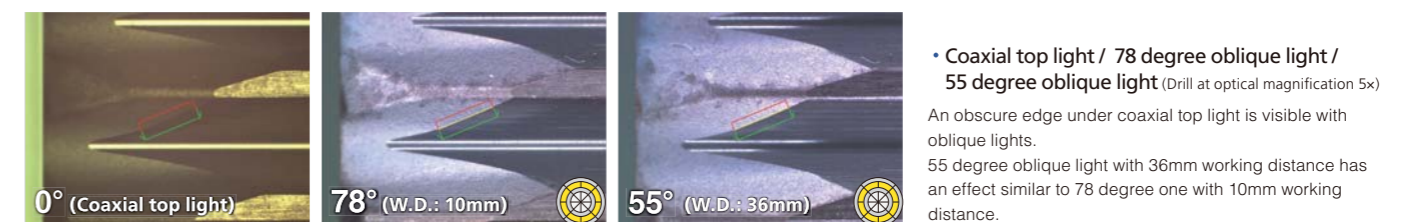

- **Coaxial top light / 78 degree oblique light / 55 degree oblique light** (Drill at optical magnification 5x)  
An obscure edge under coaxial top light is visible with oblique lights. 55 degree oblique light with 36mm working distance has an effect similar to 78 degree one with 10mm working distance.

## Type 4 – High magnification zooming head

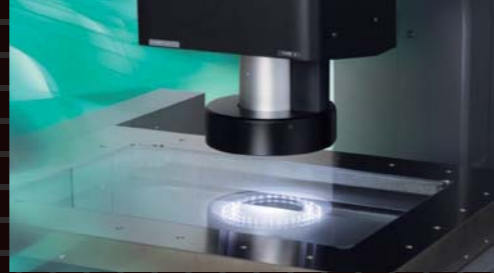

## Type TZ – High magnification zooming head

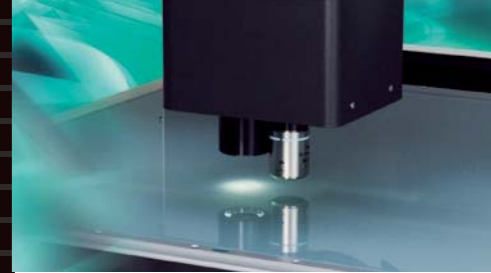

### For measuring tiny features

Type 4

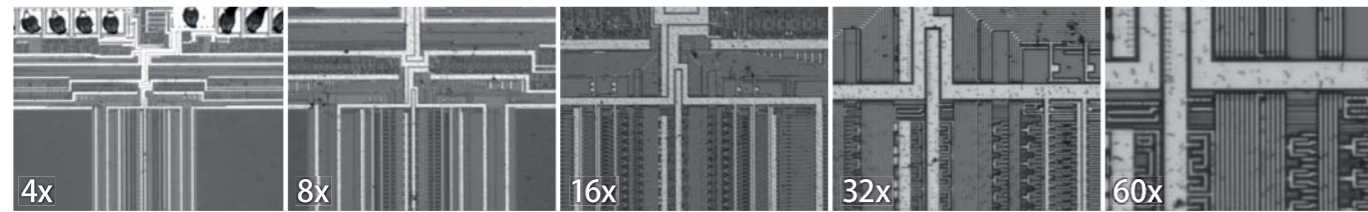

Type 4, having a 4 to 60x optical magnification, twice the magnification of the Type 3, is designed for tiny features in high density specimen. Its objective lens is newly designed with a high N.A. 0.46 and a long working distance 30mm.

Optical magnification		4	8	16	32	60
FOV size on stage	Horizontal x Vertical (mm)	1.165	0.582	0.291	0.146	0.07
		0.875	0.437	0.218	0.109	0.068
1/3" CCD size	Horizontal x Vertical (mm)	4.8x3.6				
Video magnification		36				
Total magnification on Video Window (640 x 480 pixels)		144	288	576	1152	2160
Size of 1 pixel (micrometer)		1.84	0.82	0.46	0.23	0.12
Size of objects on Video Window (640 x 480 pixels)	0.01x (mm)	1.44	2.88	5.76	11.52	21.6
	0.1x (mm)	14.4	28.8	57.6	115.2	216
	1x (mm)	144	288	576	1152	2160

\* Total magnification is that of video window with 640 x 480 pixels on 24 inch WUXGA monitor (1920 x 1200 pixels) recommended for VMZ-R series.

### High magnification head equipped with 8 segment LED ring illuminator

Type 4

Type 4 is equipped with 8 segment LED ring illuminator as well as episcopic and diascope illuminators, that make obscure edges stand out.

• **8 segment LED ring illuminator**  
8 segment LED ring illuminator has 10 degree oblique angle against optical axis and 30mm working distance.



High density PCB  
Under coaxial top light  
at optical magnification 4x

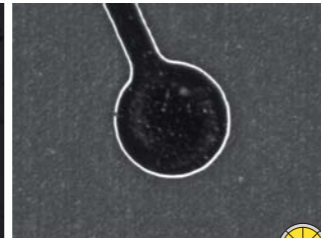

Lead frame  
Under bottom light  
at optical magnification 4x

### TTL Laser AF and image AF

Type 4

#### TTL Laser AF with 30mm working distance

TTL Laser AF can detect surfaces accurately and is repeatable, it is independent of magnification. It can scan surfaces with a maximum of 1000 points per second to analyze surfaces. It can also detect not only the top surface of a top layer but also its bottom surface or the top surface of the second layer.

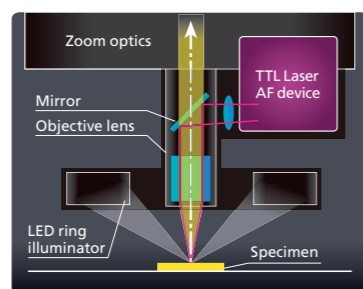

TTL Laser AF schematic

#### Image AF

Image AF can detect a surface which Laser AF cannot reach, such as the bottom of a deep hole. It can also be used to get an average height of a rough surface, height of a steep surface, etc..

### Type TZ zooming head range 1x to 120x

Type TZ

Type TZ high magnification zooming head is equipped with 2 objective lenses, the left one covering 1 to 7.5x mainly for finding features to measure and the main one at the right covering 16 to 120x for measuring tiny features such as 1 micrometer line width. Both of the objective lenses, have a calibrated 50mm X offset, and the machine can be switched easily between the two lenses.

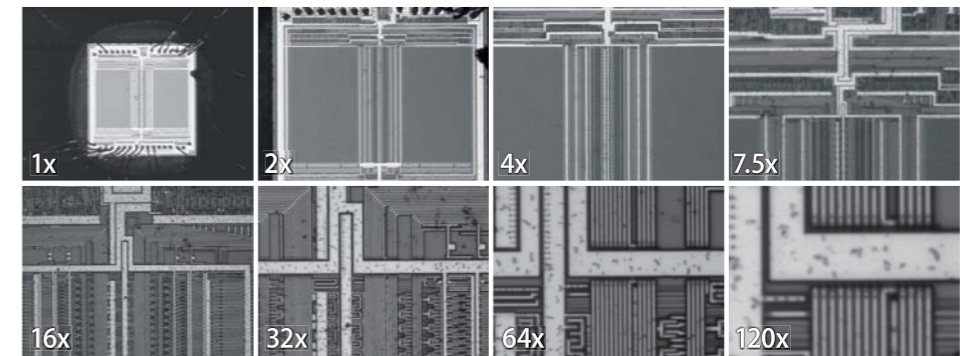

Optical magnification		1	2	4	7.5	16	32	64	120
FOV size on stage	Horizontal x Vertical (mm)	4.7	2.33	1.165	0.622	0.291	0.146	0.073	0.039
		3.5	1.75	0.875	0.467	0.218	0.109	0.055	0.029
1/3" CCD size	Horizontal x Vertical (mm)	4.8x3.6							
Video magnification		36							
Total magnification on Video Window (640 x 480 pixels)		36	72	144	270	576	1152	2304	4320
Size of 1 pixel (micrometer)		7.36	3.68	1.84	0.98	0.46	0.23	0.11	0.06
Size of objects on Video Window (640 x 480 pixels)	0.01x (mm)	0.36	0.72	1.44	2.7	5.76	11.52	23.04	43.2
	0.1x (mm)	3.6	7.2	14.4	27	57.6	115.2	230.4	432
	1x (mm)	36	72	144	270	576	1152	2304	4320

\* Total magnification is that of video window with 640 x 480 pixels on 24 inch WUXGA monitor (1920 x 1200 pixels) recommended for VMZ-R series.

### High performance TTL Laser AF

Type TZ

Type TZ main objective lens has TTL Laser AF built-in. High NA (0.55) lens has the highest performance in terms of detecting and scanning.

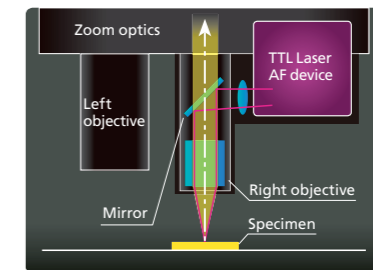

TTL Laser AF schematic

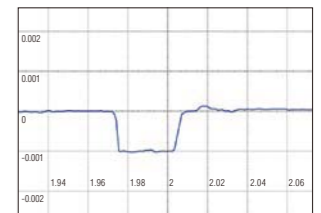

Cross section of a small groove

### Versatile illuminations

Type TZ

Both of the objective lenses are equipped with episcopic and dark field illuminators giving coaxial top light and oblique light respectively. The right main objective lens has diascope illuminator giving bottom light.

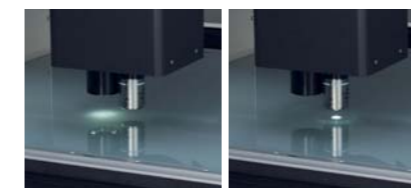

• **2 objective lenses covering 1 to 120x**  
The left one for 1 to 7.5x  
The main one for 16 to 120x

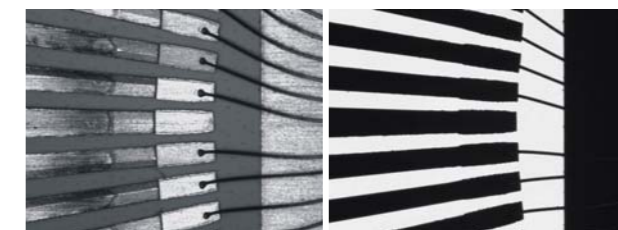

Lead frame  
Under coaxial top light  
at optical magnification 16x

Under bottom light

High density PCB  
Under dark field illumination  
at optical magnification 16x

# Type A – Wide FOV zooming head



## Wide FOV and long working distance

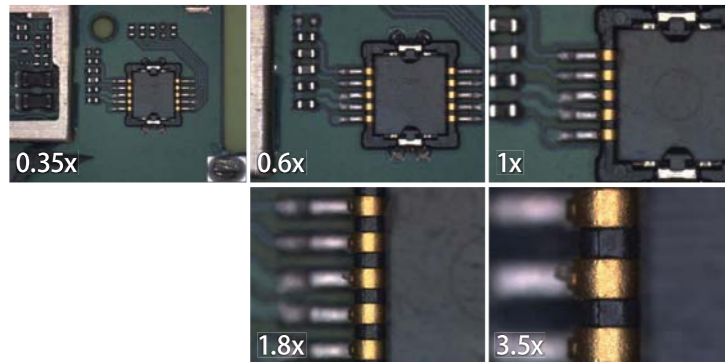

Optical magnification		0.35	0.6	1	1.8	3.5
FOV size on stage	Horizontal (mm)	13.3	7.8	4.7	2.6	1.33
	Vertical (mm)	10.0	5.8	3.5	1.9	1.00
1/3" CCD size	Horizontal (mm)	4.8x3.6				
	Vertical (mm)	4.8x3.6				
Video magnification		36				
Total magnification on Video Window (640 x 480 pixels)		12.6	21.6	36	64.8	126
Size of 1 pixel (micrometer)		21.8	12.6	7.36	4.25	2.15
Size of objects on Video Window (640 x 480 pixels)	0.01x (mm)	0.126	0.216	0.36	0.648	1.26
	0.1x (mm)	1.26	2.16	3.6	6.48	12.6
	1x (mm)	12.6	21.6	36	64.8	126

\* Total magnification is that of video window with 640 x 480 pixels on 24 inch WUXGA monitor (1920 x 1200 pixels) recommended for VMZ-R series.

### Max. 13.3 x 10mm FOV at 0.35x

Suitable for large specimen with large features to measure.

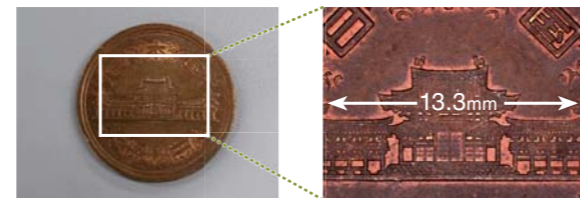

10 yen coin Under coaxial top light at 0.35x optical magnification

### Long working distance 73.5mm

The objective lens is designed for Type A zooming head where a wide FOV, a long working distance and a high N.A. 0.11 are compatible. Suitable for low density specimen with big steps, deep holes, tall bosses, etc.



Working distance 73.5mm Assembled components Under coaxial top light at 0.35x optical magnification

## Image AF and Laser AF

### Image AF

The search probe can detect misaligned parts, and rotate the program to suit. Allowing the machine to successfully measure the part.

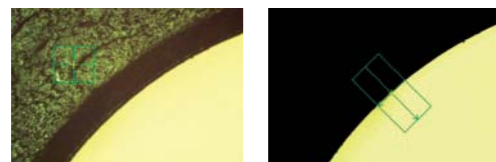

Focusing on a surface (Surface mode)

Focusing on an edge (Contrast mode)

### Laser AF option

Laser AF for Type A has 63mm working distance and high accuracy, it is independent of magnification and its depth of focus.

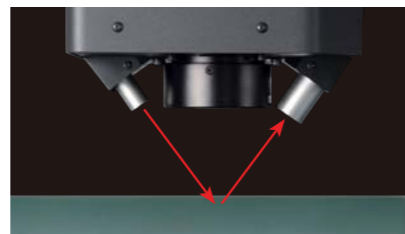

## Versatile illuminations

Type A zooming head is equipped with episcopic, diasopic and 8 segment ring illuminators of all LED. The oblique angle of the 8 segment ring illuminator is 18 degrees. Combination of these illuminations with the excellent objective lens enable you to visualize obscure edges.



Plastic molded part Under coaxial top light at 0.35x optical magnification

Under bottom light

Under 8 segment LED ring light

# Software

## Software with new GUI for easier operations

**NEW**

The new graphical user interface (GUI) simplifies machine movement, creating and running teaching files, and clearly indicates status and progress of measurements.

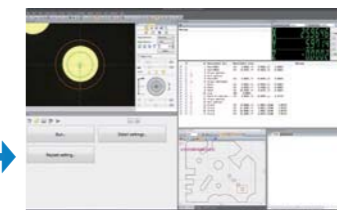
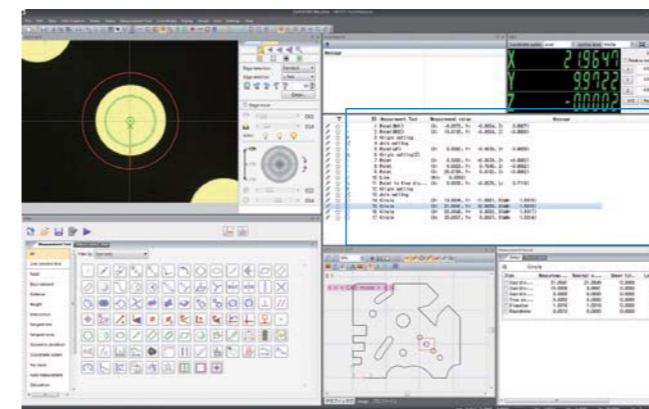

Various wizards for guiding procedures of measurements are available, providing fast, easy writing of teaching files. GUI can be customized for different tasks. You can select and hide functions for achieving your tasks.

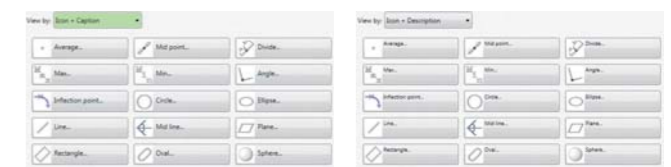

Change of indication of measure tools

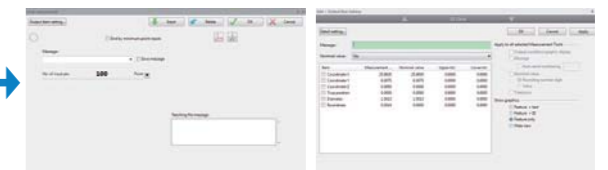

Main window changes its function according to situation.

## Functions supporting automatic and accurate measurements

### Edge and point selection

You can preset rules for selecting a correct edge from multiple edge candidates and a filter to avoid abnormal points to minimize errors.

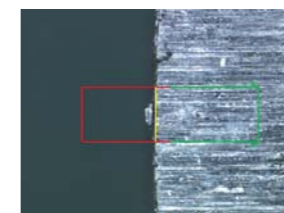

### Intelligent search function

You can save images to a teach file to enable the machine to search for them. With this function a misaligned specimen can be found and measured without failure.

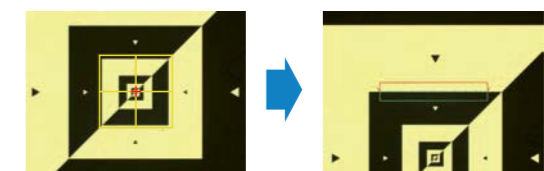

Save an image of the center and record the position



The search probe can detect misaligned parts, and rotate the program to suit. Allowing the machine to successfully measure the part.

### Automatic adjustment of light intensity

You can have a choice from 3 distinct levels of light intensities, Low, Middle and High, for coaxial top and bottom lights by clicking one of 3 buttons.



## Other useful functions for making teaching files

### Import of CAD data

CAD data can be imported and shown in the graphic window.

### Export of DXF data

Features measured can be exported as DXF data.

### Off-line teaching

Teaching files can be made on CAD data.

# Software

## NEXIV Profiler

### Calculation of features and deviations based on ISO and JIS

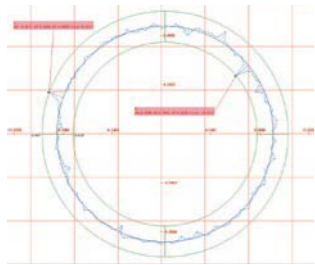

- **Circle**  
Roundness based on least square or minimum zone method, maximum inscribed circle, minimum circumscribed circle

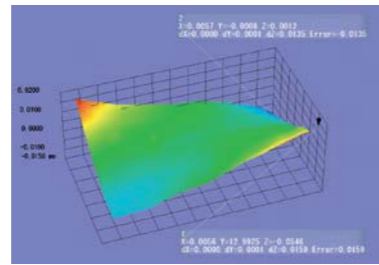

- **Plane**  
Flatness based on least square or minimum zone method, plane defined by the highest or lowest 3 points

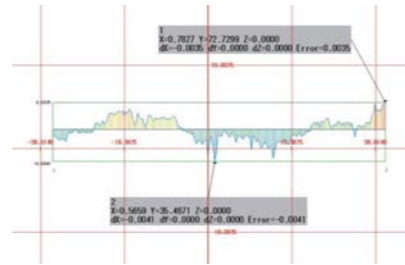

- **Line**  
Straightness based on least square or minimum zone method, line defined by 2 points at both ends.

### Evaluation of shapes (contours)

Nominal and measured shapes can be overlaid and errors can be visualized. Best fit function shifts and rotates measured shapes to nominal shapes to minimize errors. Good for both geometrical shapes and free-form shapes.

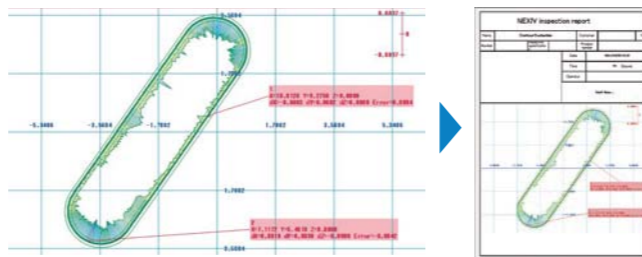

- Calculation of errors can be made in either normal or axis direction.
- Nominal shapes can be made from either CAD data or XYZ coordinate values.
- Measured shapes can be output in CSV or DXF file.
- Evaluation report can be made in PDF file.

### Editing of imported CAD data

Change of tolerances, directions of elements, size, etc., can be made in NEXIV profiler.

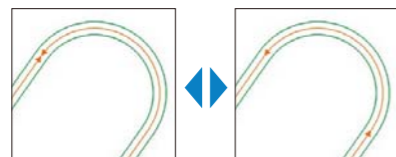

## NEXIV Report

Reports can be made with results and graphics. You can choose which results and graphics to show and can change layouts. Once the report is made, it can be automatically created every time the program is run.

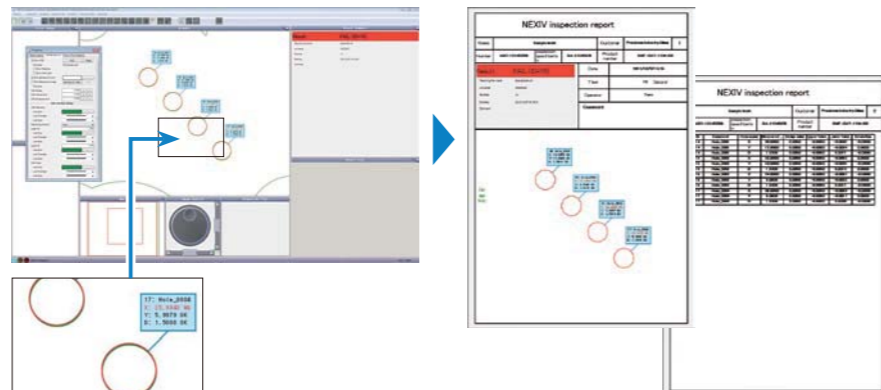

# Options

## EDF/Stitching Express

The software can stitch images on XY planes to get a larger image as well as images at different height along with Z axis to get an image with an Extended Depth of Focus (EDF). It can make 3D graphics based on EDF and Stitched images.

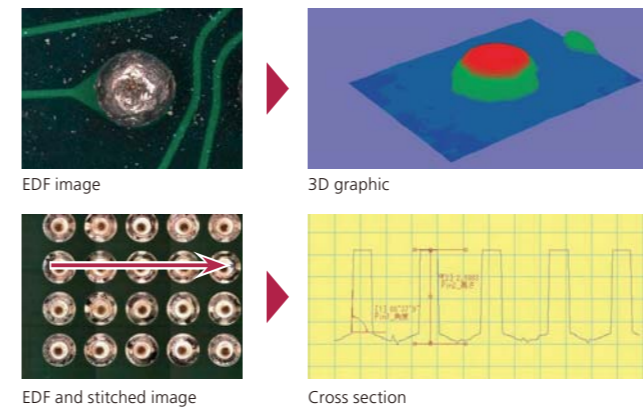

## D-Surf (by Kosaka Laboratory Ltd., Japan)

A CSV file containing XYZ coordinates of points acquired by Laser scanning on a surface can be read by D-Surf software and used to analyze the surface.

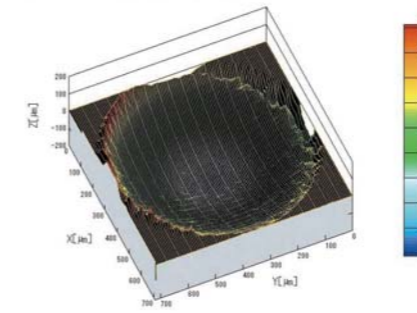

## Custom Fit QC (by Aria Co., Ltd.)

The software can make measurement reports easily. 10 standard formats are supplied as standard and new formats can be made. It can handle angle in degree, minute and seconds and can create graphics automatically. Custom Fit QC can create histograms, X-R chart, scatter diagrams, etc., used in QC.

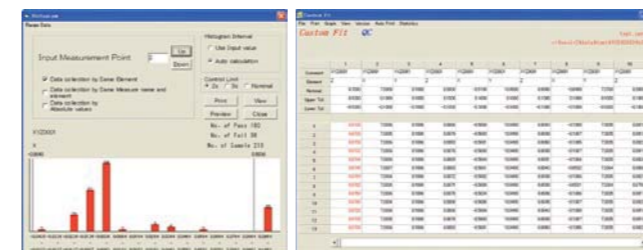

## MountainsMap X (by Digital Surf, France)

A CSV file containing XYZ coordinates of points acquired by Laser scanning on a surface can be read by MountainsMap software, which can analyze the surface based on ISO.

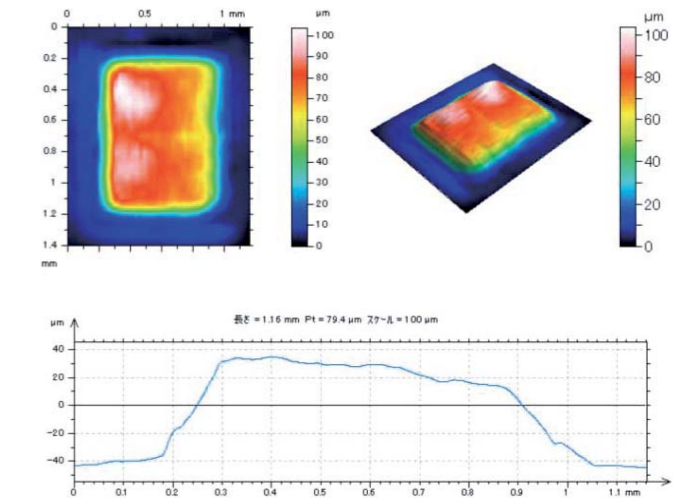

## Anti-vibration Table (by Showa Science Co., Ltd.)

A passive anti-vibration table is available for floor with large vibrations.



## Signal Tower

Showing status of your NEXIV with 3 colors.



# Specifications and dimensions

## Specifications

Model	VMZ-R 3020	VMZ-R 4540	VMZ-R 6555
<b>XYZ strokes</b>			
Type 1, 2, 3 and 4	300×200×200mm	450×400×200mm	650×550×200mm
Type TZ with the main objective lens	300×200×200mm	450×400×200mm	650×550×200mm
Type TZ with the main objective lens	250×200×200mm	400×400×200mm	600×550×200mm
Type A	300×200×200mm	450×400×200mm	650×550×200mm
Minimum reading unit	0.01 micrometer		
Maximum weight of specimen	20kg	40kg	50kg
<b>Uncertainty (L: Length in mm)</b>			
EUX, MPE EUY, MPE	1.2+4L/1000μm		
EUXY, MPE	2+4L/1000μm		
Z axis uncertainty (with Laser AF)	1.2+5L/1000μm		
Camera	Black & white 1/3" CCD, Color 1/3" CCD (Option)* *Color camera option is available only with Type 1, 2 and A.		
<b>Working distance of objective lens</b>			
Type 1, 2 and 3	50mm with 37 degree oblique angle, 36mm with 55 degree oblique angle, 10mm with 78 degree oblique angle		
Type 4	30mm		
Type TZ	11mm with the main objective lens and 32mm with the left objective lens.		
Type A	73.5mm without Laser AF, 63mm with Laser AF		
<b>Magnification and FOV</b>			
Type 1	0.5 ~ 7.5× / 9.33×7 ~ 0.622×0.467mm		
Type 2	1 ~ 15× / 4.67×3.5 ~ 0.311×0.233mm		
Type 3	2 ~ 30× / 2.33×1.75 ~ 0.155×0.117mm		
Type 4	4 ~ 60× / 1.165×0.875 ~ 0.07×0.068mm		
Type TZ	1 ~ 120× / 4.67×3.5 ~ 0.039×0.029mm		
Type A	0.35 ~ 3.5× / 13.3×10 ~ 1.33×1mm		
Autofocus	Type 1, 2, 3, 4 and TZ are equipped with TTL Laser AF and image AF. Type A is equipped with image AF as standard and with Laser AF as an option		
<b>Illuminators</b>			
Type 1, 2 and 3	LED episcopic and diascope illuminators 8 segment LED inner and outer ring illuminators (37 degree oblique angle with inner ring and 55 and 78 degree oblique angles with outer ring)		
Type TZ	LED episcopic illuminator and LED Dark Field illuminator for the main and left objective lenses LED diascope illuminator for the main objective lens		
Type A	LED episcopic and diascope illuminators 8 segment LED ring illuminator with 18 degree oblique angle		
Requirements	AC 100-240V±10% 50 or 60 Hz		
Consumption of currency	5A-2.5A		
<b>Dimensions and weight</b>			
Main body and table	700×730×1795mm/ approx. 245kg	1000×1340×1820mm/ approx. 500kg	1200×1640×1820mm/ approx. 665kg
Controller	190×450×440mm/15kg		
Footprint including a PC on table	2100×1100mm	2300×1700mm	2400×2000mm

## Dimensions

### VMZ-R 6555

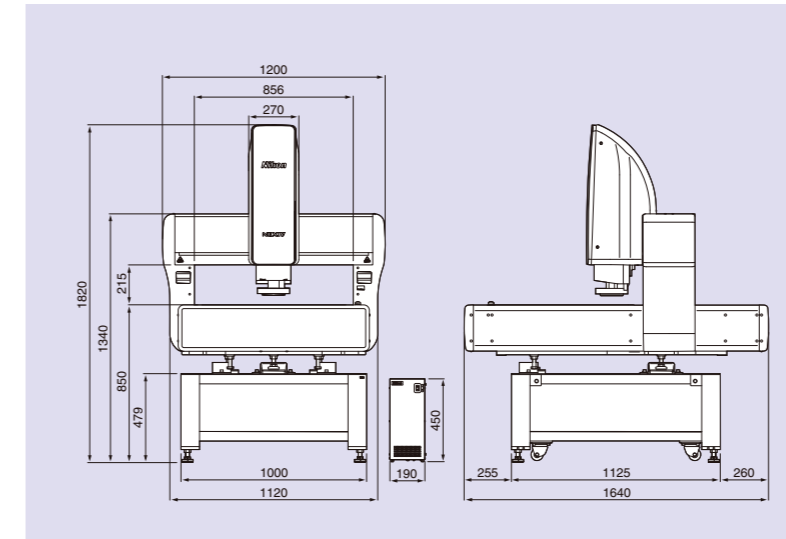

Stage with thread holes for fixtures

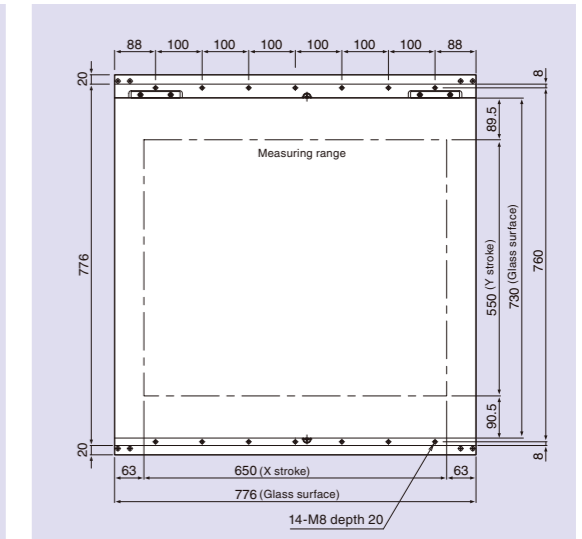

### VMZ-R 4540

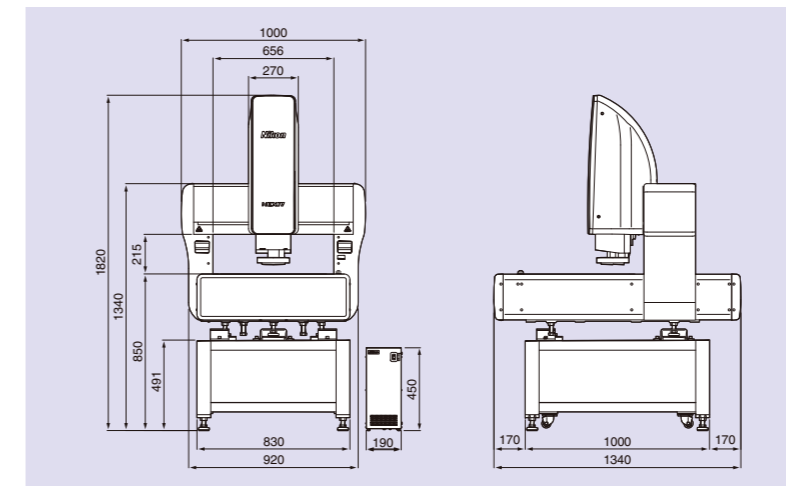

Stage with thread holes for fixtures

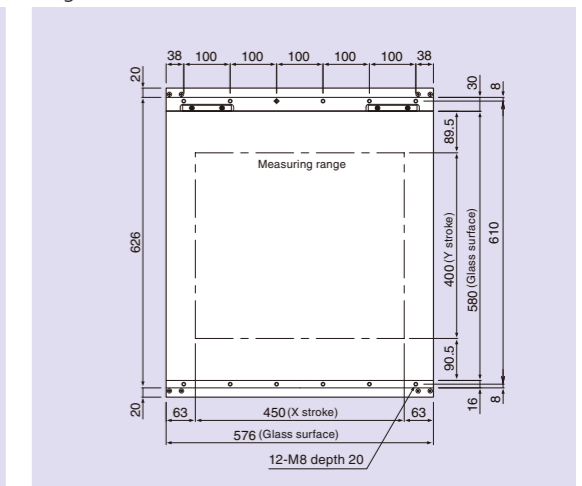

### VMZ-R 3020

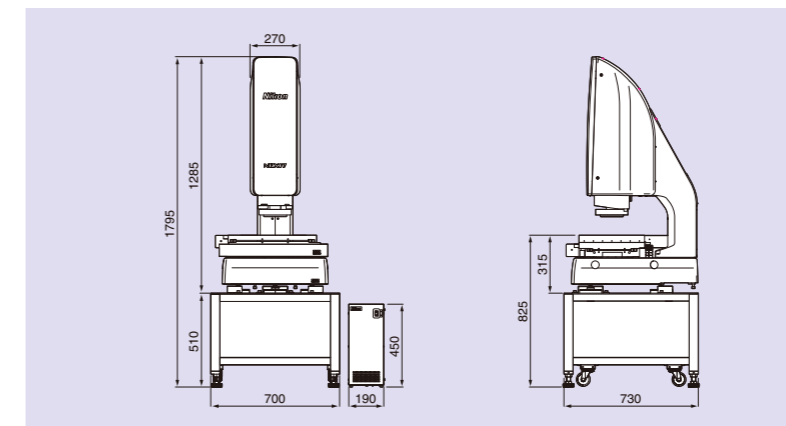

Stage with thread holes for fixtures

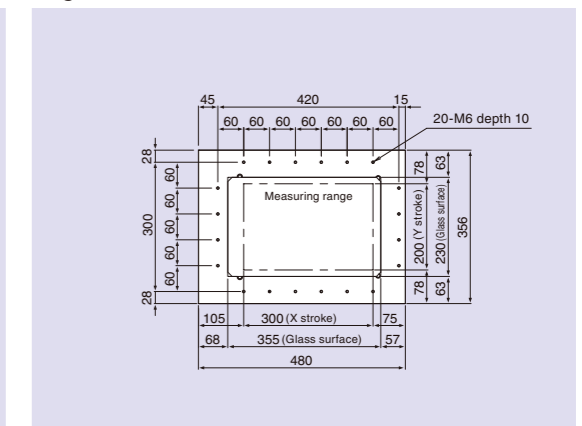



Specifications and equipment are subject to change without any notice or obligation on the part of the manufacturer. October 2013 ©2013 NIKON CORPORATION

N.B. Export of the products\* in this catalog is controlled under the Japanese Foreign Exchange and Foreign Trade Law. Appropriate export procedures shall be required in case of export from Japan.

\*Products: Hardware and its technical information (including software)

• Monitor images are simulated. Company names and product names in this brochure are their registered trademarks or trademarks.



**WARNING** TO ENSURE CORRECT USAGE, READ THE CORRESPONDING MANUALS CAREFULLY BEFORE USING THE EQUIPMENT.



ISO 9001 Certified  
for NIKON CORPORATION  
Instruments Company



ISO 14001 Certified  
for NIKON CORPORATION  
Yokohama Plant

ryf ag  Ryf AG  
Bettlachstrasse 2  
2540 Grenchen  
tel 032 654 21 00  
fax 032 654 21 09  
[www.ryfag.ch](http://www.ryfag.ch)

